



## MICRO BORING

### FBH Micro Boring Tools - Characteristics

Adjustment precision 0.002 mm on diameter.

One boring head with cartridge or boring bar can be used for boring and back boring.

Standard insert holder for inserts with lead angle 3°, for a better working performance during blind hole boring.

The extensive area serrated with connection between cartridge and boring head provides higher tool rigidity and working performance.

All DCK-FBH fine boring tools are with internal cooling design, which increases the surface finish and inserts tool life.

### FBH Back Boring Instructions

In order to check the feasibility of the back boring operation and to select the best possible tool combination, these values can be calculated as follows:

$$C = (D+d) / 2$$

C: Minimum entry bore diameter

D: Back bore diameter

d: Diameter of tool body

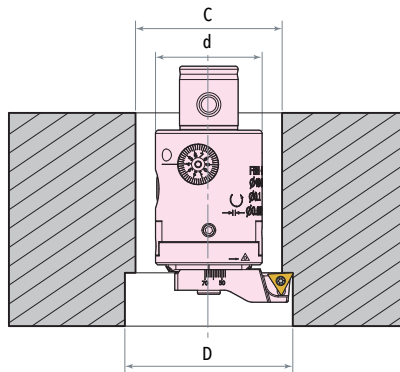



## FBH Micro-boring Tool

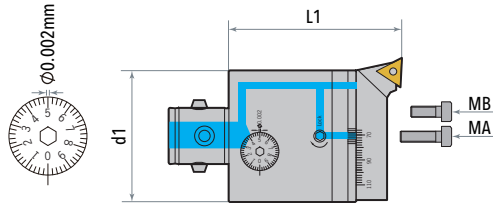

Specification	d1	L1	Boring range	Adapter size	Cartridge	Adjusting screw	Wrench	Weight
DCK2-FBH25-M	25	55	29-38	DCK6	MLTP2938	M040U050-D	T02	1.70
DCK3-FBH32-M	32	65	36-52	DCK6	MLTP3652	M040U060-D	T02	3.50
DCK4-FBH40-M	40	65	48-68	DCK5	MLTP4868	M050U080-D	T025	0.15
DCK5-FBH50-BM	50	82	57-80	DCK2	MLTP5780	M060U080-D	T03	0.33
DCK6-FBH63-BMA	64	82	70-110	DCK3	MLTP70110	M060U120-D	T03	0.53
DCK6-FBH80-BMB	80	101	110-150	DCK4	MLTP110150	M060U200-D	T03	1.02

## FBH Micro Back-boring Tool

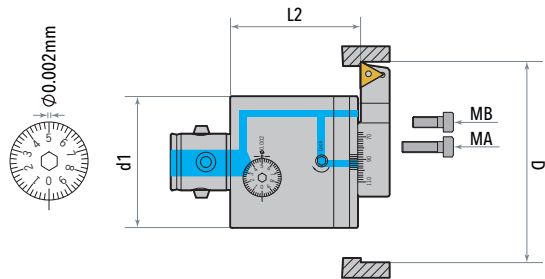

Specification	d1	L2	Boring range	Adapter size	Cartridge	Adjusting screw	Wrench	Weight
DCK2-FBH25-MK	25	44	29-38	DCK6	MRTP2938	M040U050-D	T02	1.50
DCK3-FBH32-MKD	32	53.5	36-52	DCK6	MRTP3652	M040U060-D	T02	3.30
CK4-FBH40-MK	40	53.5	48-68	DCK5	MRTP4868	M050U080-D	T025	0.13
DCK5-FBH50-BMK	50	63	57-80	DCK2	MRTP5780	M060U080-D	T03	0.30
DCK6-FBH63-BMKA	64	63	70-110	DCK3	MRTP70110	M060U120-D	T03	0.50
DCK6-FBH80-BMKB	80	81	110-150	DCK4	MRTP110150	M060U200-D	T03	1.00



## MICRO BORING

### FBH Micro-boring Head

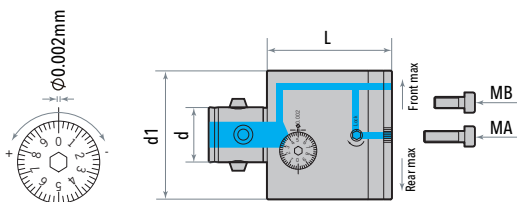

Specification	d	d1	L	Front	Rear	BM	MA Bolt	MB Bolt	Wrench	Weight
DCK2-FBH25	14	25	43	1	1	-	E050U160-D	-	L04	0.10
DCK3-FBH32	18	32	53	1	1	BM7	E050U160-D	-	L04	0.31
DCK4-FBH40	22	40	53	2	2	BM7	E050U160-D	-	L04	0.20
DCK5-FBH50	28	50	63	2	2	BM8	E100U250-D	-	L08	0.93
DCK6-FBH63	36	64	63	2	2	BM8	E100U250-D	-	L08	1.56
DCK6-FBH80	36	80	80	4	4	BM8	E100U250-D	E100U160-D	L08	2.91

### FBH Micro-boring Bar

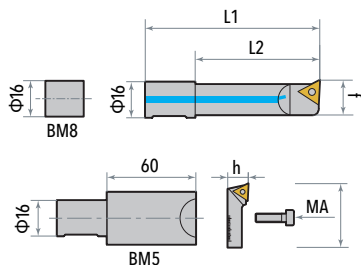

Specification	L1	L2	Boring range	Boring body	Insert	Insert screw	Wrench	Weight	
DR	1606-21	56	21	6-9	DCK5-FBH50 DCK6-FBH63 DCK6-FBH80	WBGTO601..	M020W040	Q06	0.04
	1608-28	63	28	8-11		LTBGT0601..	M020W040	Q06	0.04
	1610-35	63	35	10-13		LTBGT0601..	M020W040	Q06	0.05
	1612-42	73	42	12-15		LTPGH0902..	M025W060	Q08	0.06
	1614-50	78.5	50	14-17		LTPGH0902..	M025W060	Q08	0.08
	1616-60	88	60	16-20		LTPGH0902..	M025W060	Q08	0.11
	1620-65	92	65	20-24		LTPGH1103..	M030W070	Q08	0.16
	1624-68	95	68	24-28		LTPGH1103..L	M030W070	Q08	0.20
BM5	60+MLTP2938orMLTP3652orMLTP4868					E050U160-D	-	0.25	
BM8	+MLTP5780orMLTP70110orMLIP110150					E100U250-D	-	0.04	



**FBH**  
Cartridge for FBH Boring Tool

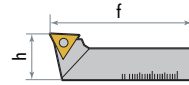

Specification	h	f	Boring range	Boring head	Insert	Insert screw	Wrench	Weight	
MLTP	2938	11	27	29-38	DCK2-FBH25	TPGH0902..L	M025W050	Q08	0.01
	3652	13	35	36-52	DCK3-FBH32	TPGH0902..L	M025W060	Q08	0.02
	4868	13	43	48-68	DCK4-FBH40	TPGH0902..L	M025W060	Q08	0.03
	5780	20	54	57-80	DCK5-FBH50	TPGH1103..L	M030W070	Q08	0.09
	70110	20	66	70-110	DCK6-FBH63	TPGH1103..L	M030W070	Q08	0.14
	110150	20	106	110-150	DCK6-FBH80	TPGH1103..L	M030W070	Q08	0.25

**FBH**  
Cartridge for FBH Back-boring Tool

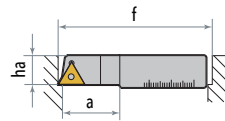

Specification	a	ha	f	Boring range	Boring head	Insert	Insert screw	Wrench	Weight	
MRTP	2938	6	11	27	29-38	DCK2-FBH25	TPGH0902..R	M025W050	Q08	0.01
	3652	10	11	35	36-52	DCK3-FBH32	TPGH0902..R	M025W060	Q08	0.02
	4868	12	11	43	48-68	DCK4-FBH40	TPGH0902..R	M025W060	Q08	0.03
	5780	14	15	54	57-80	DCK5-FBH50	TPGH1103..R	M030W070	Q08	0.08
	70110	16	15	66	70-110	DCK6-FBH63	TPGH1103..R	M030W070	Q08	0.12
	110150	25	15	106	110-150	DCK6-FBH80	TPGH1103..R	M030W070	Q08	0.19



# MICRO BORING

## DCK3-FBH32P Micro-finishing Boring Kit

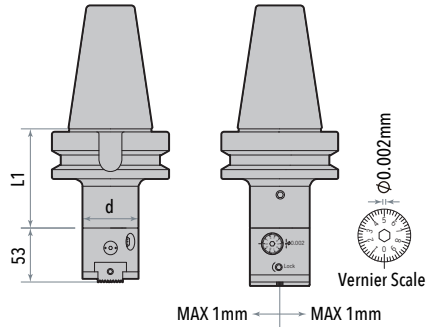

Specification	L1	Boring range	Adapter size	Weight
HSK63A-DCK3-FBH32P	80	2-9	BT30-DCK3-80	1.50
BT30-DCK3-FBH32P	80	2-9	HSK63A-DCK3-80	1.02
BT40-DCK3-FBH32P	80	2-9	BT40-DCK3-80	1.61
SK40-DCK3-FBH32P	80	2-9	SK40-DCK3-80	1.61

Boring bar	Boring range	DM	Weight
CA	0802-10	2-3.2	10 0.03
	0803-16	3-4.2	16 0.03
	0804-22	4-5.2	22 0.03
	0805-28	5-6.2	28 0.04
	0806-32	6-7.2	32 0.04
	0807-37	7-8.2	37 0.04
	0808-42	8-9.2	42 0.05

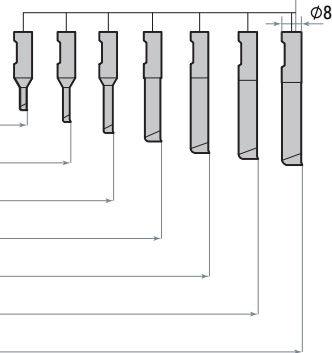



**DCK4-FBH40P**  
Micro-finishing Boring Kit

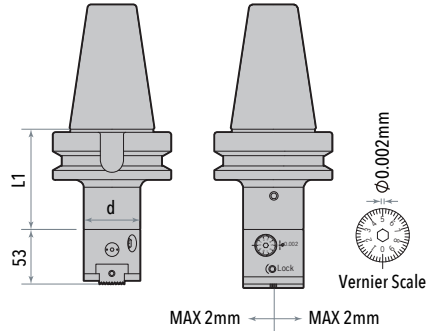

Specification	L1	Boring range	Adapter size	Weight
HSK63A-DCK4-FBH40P	70	2-9	HSK63A-DCK4-70	2.50
BT30-DCK4-FBH40P	70	2-9	BT30-DCK4-70	1.21
BT40-DCK4-FBH40P	70	2-9	BT40-DCK4-70	1.61
SK40-DCK4-FBH40P	70	2-9	SK40-DCK4-70	1.61

Boring bar	Boring range	DM	Weight
CA 0802-10	2-3.2	10	0.03
0803-16	3-4.2	16	0.03
0804-22	4-5.2	22	0.03
0805-28	5-6.2	28	0.04
0806-32	6-7.2	32	0.04
0807-37	7-8.2	37	0.04
0808-42	8-9.2	42	0.05

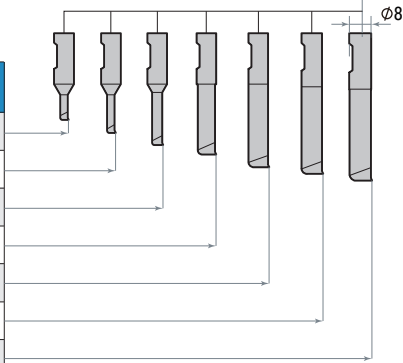



# MICRO BORING

## DCK5-FBH50P Micro-finishing Boring Kit

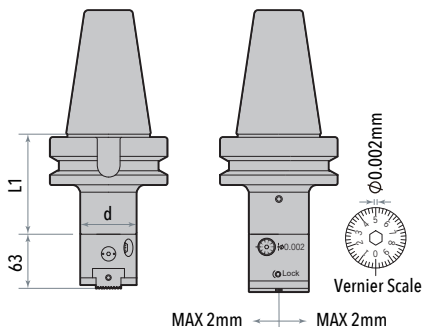

Specification	L1	Boring range	Adapter size	BM Locking screw	Wrench	Weight
HSK63A-DCK5-FBH50P	80	6-80	HSK63A-DCK5-80	M100U160-90-D	L05	4.02
BT30-DCK5-FBH50P	70	6-80	BT30-DCK5-70	M100U160-90-D	L05	0.90
BT40-DCK5-FBH50P	80	6-80	BT40-DCK5-80	M100U160-90-D	L05	3.54
BT50-DCK5-FBH50P	90	6-80	BT50-DCK5-90	M100U160-90-D	L05	6.32
SK40-DCK5-FBH50P	80	6-80	SK40-DCK5-80	M100U160-90-D	L05	3.54
SK50-DCK5-FBH50P	90	6-80	SK50-DCK5-90	M100U160-90-D	L05	6.32

Boring bar	Boring range	DM	Insert	Weight
DR1606-21	6-9	21	WBGTO601..L	0.04
DR1608-28	8-11	28	TBGT0601..L	0.04
DR1610-35	10-13	35	TBGT0601..L	0.05
DR1612-42	12-15	42	TPGH0902..L	0.06
DR1614-50	14-17	50	TPGH0902..L	0.07
DR1616-60	16-20	60	TPGH0902..L	0.09
DR1620-65	20-24	65	TPGH1103..L	0.11
DR1624-68	24-28	68	TPGH1103..L	0.12
BM5	60+MLTP2938 or MLTP3652 or MLTP4868			0.25
MLTP2938	28-38	+11	TPGH0902..L	0.01
MLTP3652	36-52	+13	TPGH0902..L	0.02
MLTP4868	48-68	+13	TPGH0902..L	0.03
BM8	+MLTP5780			0.03
MLTP5780	57-80	+20	TPGH1103..L	0.10

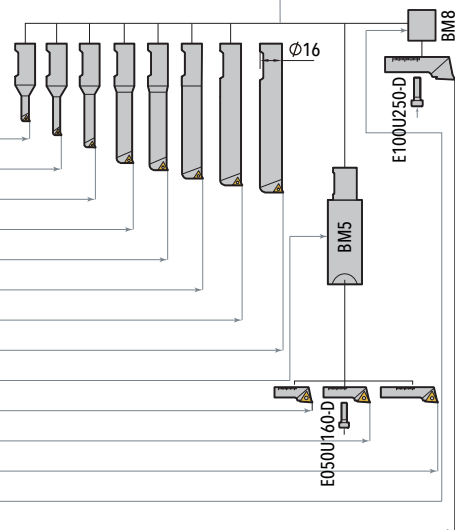



## DCK6-FBH63P Micro-finishing Boring Kit

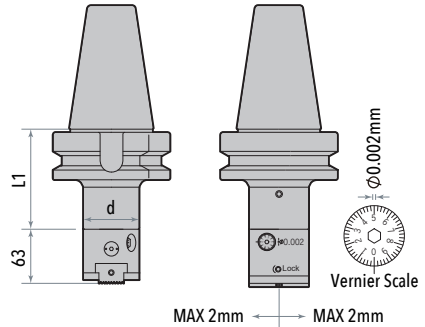

Specification	L1	Boring range	Adapter size	BM Locking screw	Wrench	Weight
HSK63A-DCK6-FBH63P	100	6-150	HSK63A-DCK6-100	M100U200-90-D	L05	5.90
BT30-DCK6-FBH63P	60	6-150	BT30-DCK6-60	M100U200-90-D	L05	4.00
BT40-DCK6-FBH63P	55	6-150	BT40-DCK6-55	M100U200-90-D	L05	4.50
BT50-DCK6-FBH63P	85	6-150	BT50-DCK6-85	M100U200-90-D	L05	9.17
SK40-DCK6-FBH63P	90	6-150	SK40-DCK6-90	M100U200-90-D	L05	4.50
SK50-DCK6-FBH63P	85	6-150	SK50-DCK6-85	M100U200-90-D	L05	9.17

Boring bar	Boring range	DM	Insert	Weight
DR1606-21	6-9	21	WBGTO601..L	0.04
DR1608-28	8-11	28	TBGT0601..L	0.04
DR1610-35	10-13	35	TBGT0601..L	0.05
DR1612-42	12-15	42	TPGH0902..L	0.06
DR1614-50	14-17	50	TPGH0902..L	0.07
DR1616-60	16-20	60	TPGH0902..L	0.09
DR1620-65	20-24	65	TPGH1103..L	0.11
DR1624-68	24-28	68	TPGH1103..L	0.12
BM5	60+MLTP2938 or MLTP3652 or MLTP4868			0.25
MLTP2938	28-38	+11	TPGH0902..L	0.01
MLTP3652	36-52	+13	TPGH0902..L	0.02
MLTP4868	48-68	+13	TPGH0902..L	0.03
BM8	+MLTP5780 or MLTP70110 or MLTP110150			0.03
MLTP5780	66-80	+20	TPGH1103..L	0.10
MLTP70110	70-110	+20	TPGH1103..L	0.10
MLTP110150	110-150	+20	TPGH1103..L	0.21

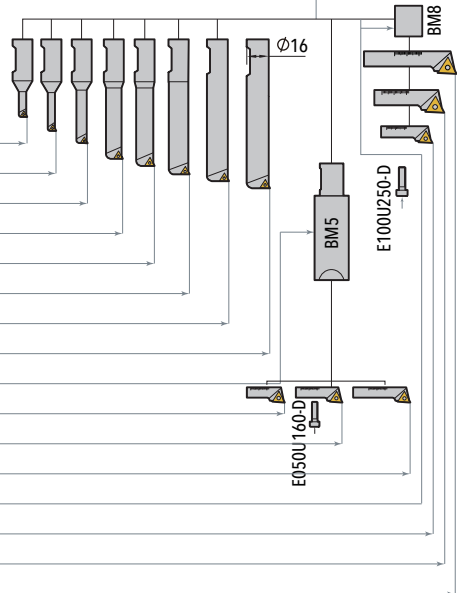

Suitable: DEREK、KYOCERA Or SUMITOMO Insert



# MICRO BORING

## DCK6-FBH80 Micro-finishing Boring Tool

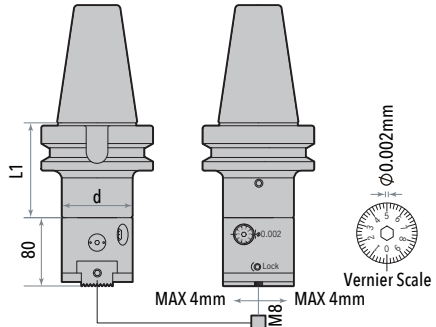

Specification	L1	Boring range	Adapter size	BM Locking screw	Wrench	Weight
HSK63A-DCK6-FBH63P	100	110-150	HSK63A-DCK6-100	M100U250-90-D	L05	7.60
BT30-DCK6-FBH63P	60	110-150	BT30-DCK6-60	M100U250-90-D	L05	5.70
BT40-DCK6-FBH63P	55	110-150	BT40-DCK6-55	M100U250-90-D	L05	6.20
BT50-DCK6-FBH63P	85	110-150	BT50-DCK6-85	M100U250-90-D	L05	10.87
SK40-DCK6-FBH63P	90	110-150	SK40-DCK6-90	M100U250-90-D	L05	6.20
SK50-DCK6-FBH63P	85	110-150	SK50-DCK6-85	M100U250-90-D	L05	10.87

Specification	Boring range	H	Locking screw	Wrench	Weight
PS140-20	+BM8	20	E050U120-D/E100U160-D	L08	0.43
MLTP2938	150-200	11	E050U160-D	L04	0.01
MLTP3652	160-210	13	E050U160-D	L04	0.02
MLTP4868	170-220	13	E050U160-D	L04	0.03
MLTP70110	140-240	20	E100U250-D	L08	0.10
MLTP110150	180-280	20	E100U250-D	L08	0.21

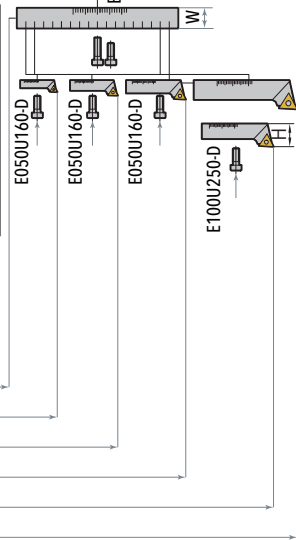



**HIGH PRECISION, HIGH STRENGTH AND EASY OPERATION**  
**--The Best Style Of Connection**

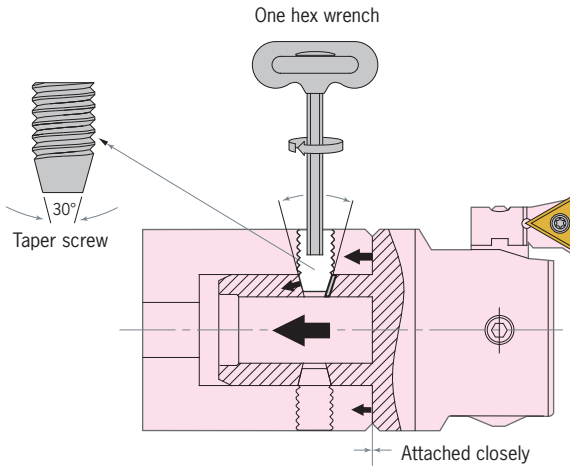

A

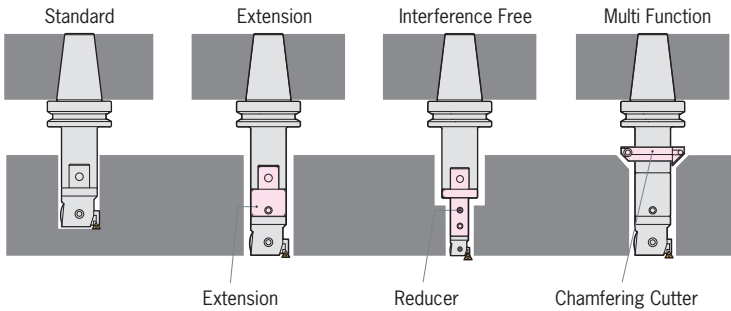

B

Change locking force to axial tension by using 30°taper screws. The boring head and arbor would be attached closely. (Fig A)  
 Modular design makes the setting of boring range and depth more easier. Reducers, extensions and chamfering rings provide multifunctional work. (Fig B)  
 High working efficiency brings down the production cost due to high precision of connection.



# MICRO BORING

## CBH

### Micro Boring Tools- Characteristics

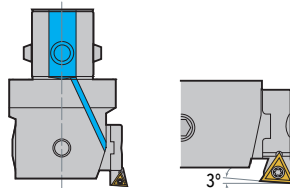

Each boring head has three different size cartridges for different boring range.

For machining blind hole with insert angle 3° can avoid the impact to the end surface.

Cartridge could be mounted in opposite direction for back boring.

Higher rigidity and better working performance are provided by close connection between cartridge and boring head.

All DCK-CBH micro boring tools have internal cooling design which improve surface roughness and inserts tool life.

Specification	Figure	Boring head	Specification	Figure	Boring head	Specification	Figure	Boring head	
CBH	1-1	DCK1-CBH20-36	4-1	 3°	DCK4-CBH41-74	1-1	 0°	DCK4-CBH41-74	
	1-2		4-2			1-2			
	1-3		4-3			1-3			
	2-1	DCK2-CBH25-47	5-1		 3°	DCK5-CBH53-95	2-1	 0°	DCK5-CBH53-95
	2-2		5-2				2-2		
	2-3		5-3				2-3		
	3-1	DCK3-CBH32-60	6-1		TCMT1102 (With) TPGH1103 (For choice)	DCK6-CBH68-150 DCK6-CBH100-203	3-1	TCMT1102 (For choice)	DCK6-CBH68-150 DCK6-CBH100-203
	3-2		6-2				3-2		
	3-3		6-3				3-3		

## CBH

### Back-Boring Instructions

In order to check the feasibility of the back boring operation and select the best tool combination, these values should be calculated as follows:

$$C > (D+d) / 2$$

C: Minimum entry bore diameter

D: Back bore diameter

d: Diameter of boring head

Anti-clockwise spindle rotation required.

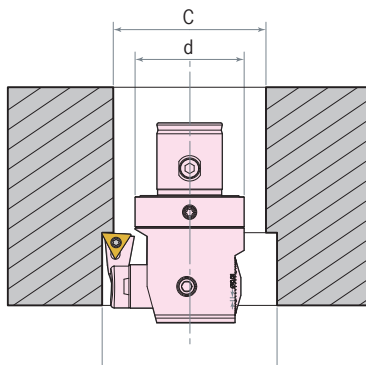



## CBH Finish Boring Tool

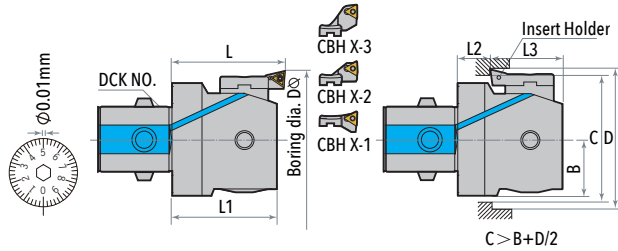

Specification	Boring		Range	Boring			Range	Cartridge	Insert	Screw	Wrench	Weight
	L1	L		B	L2	L3						
DCK1-CBH20-36	29.5	32.5	20-26	10	10.5	19	-	CBH1-1	TPGH 0802	M020D055	Q06	0.06
	29.5	32.5	25-31	10	10.5	19	-	CBH1-2				0.06
	29.5	32.5	30-36	10	10.5	19	30-36	CBH1-3				0.06
DCK2-CBH25-47	32.5	35.5	25-33	12.5	11.5	21	36-40	CBH2-1				0.12
	32.5	35.5	32-40	12.5	11.5	21	36-40	CBH2-2				0.12
	32.5	35.5	39-47	12.5	11.5	21	39-47	CBH2-3				0.12
DCK3-CBH32-60	35	40	32-42	16	10	25	-	CBH3-1				0.20
	35	40	41-51	16	10	25	46-51	CBH3-2				0.20
	35	40	50-60	16	10	25	50-60	CBH3-3				0.20
DCK4-CBH41-74	43	47	41-54	20	14	29	-	CBH4-1				0.39
	43	47	50-63	20	14	29	53-63	CBH4-2				0.39
	43	47	61-74	20	14	29	61-74	CBH4-3				0.39
DCK5-CBH53-95	53	57	53-70	25.5	19	34	62-70	CBH5-1	0.80			
	53	57	65-82	25.5	19	34	65-82	CBH5-2	0.80			
	53	57	78-95	25.5	19	34	78-95	CBH5-3	0.80			
DCK6-CBH68-150	67.2	71	68-100	32.5	22	45.2	80-100	CBH6-1	TCMT 1102 ( With ) TPGH 1103 (For choice)	M025W060 M030W070	Q08	1.80
	67.2	71	91-126	32.5	22	45.2	91-126	CBH6-2				1.80
	67.2	71	118-150	32.5	22	45.2	118-150	CBH6-3				1.80
DCK6-CBH100-203	67.2	71	100-153	45.5	22	45.2	112-153	CBH6-1				2.53
	67.2	71	126-179	45.5	22	45.2	126-179	CBH6-2				2.53
	67.2	71	150-203	45.5	22	45.2	150-203	CBH6-3				2.53
DCK7-CBH100-203	83.5	87	100-153	45.5	22	45.2	112-153	CBH6-1				3.96
	83.2	87	126-179	45.5	22	45.2	126-179	CBH6-2				3.96
	83.2	87	150-203	45.5	22	45.2	150-203	CBH6-3				3.96

### Feature

1. With internal cooling supply.
2. With balanced structure for high machining precision accuracy.
3. High effectiveness with back-boring function.
4. With side scale for adjustment of  $\mu\text{m}$  grade.



## MICRO BORING

### FM-CBH

#### Large Diameter Boring Tool For Finishing

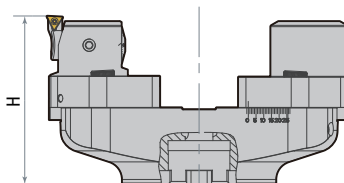
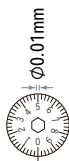

Specification		Boring range	H	Adapter size	B-Boring range	Work depth	Insert	Weight
FMS	CBH148215	148-215	109	FMS	23-90	30	TCMT1102	3.18
	CBH198265	198-265	109	FMS	73-140	30	/	3.71
	CBH248315	248-315	109	FMS	123-190	30	TPGH1103	4.19

Insert holder	Picture	Insert	Screw	Wrench	Weight
CBH5-1-TC-V		TCMT1102	M025W060	Q08	0.04
CBH5-1-TP-V		TPGH1103	M030W070	Q08	0.04

Item	Specification	Picture	Weight
Adapter size	HSK-A-FMS		-
	BT-FMS		-
	SK-FMS		-
	BBT-FMS		-
	CAT-FMS		-
Extension aluminum bridge	FMS40-148		1.46
	FMS40-198		1.99
	FMS40-248		2.47
Finish boring aluminum slider	FMA34-S17		0.29
Finish boring head	A34-CBH5395		0.55
Balancing aluminum weight	FMA34-S17-PZK		0.86

### Feature

1. 70-90% of material is made from Aluminum.
2. With internal cooling supply.
3. Balanced: G6.3;1,000 rpm.



**FM-CBH**  
Large Diameter Boring  
Tool For Finishing

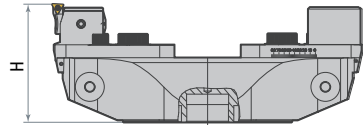

Specification		Boring range	H	Adapter size	B-Boring range	Work depth	Insert	Weight
FMX	CBH298395	298-395	113	FMX	173-270	25	TCMT1102	9.50
	CBH378475	378-475	118	FMX	253-350	25	/	11.26
	CBH458555	458-555	123	FMX	333-430	25	TPGH1103	13.19

Insert holder	Picture	Insert	Screw	Wrench	Weight
CBH5-1-TC-V		TCMT1102	M025W060	Q08	0.04
CBH5-1-TP-V		TPGH1103	M030W070	Q08	0.04

Item	Specification	Picture	Weight
Adapter size	HSK-A-FMX		-
	BT-FMX		-
	SK-FMX		-
	BBT-FMX		-
	CAT-FMX		-
Extension aluminum bridge	FMX40-298		5.33
	FMX40-378		7.09
	FMX40-458		9.02
Finish boring slider	FMA34-S24		1.02
Finish boring head	A34-CBH5395		0.55
Balancing weight	FMA34-S24-PZK		1.56

**Feature**

1. 0-90% of material is made from Aluminum.
2. With internal cooling supply.
3. Balanced: G6.3;1,000 rpm.



## MICRO BORING

### FM-CBH

#### Large Diameter Boring Tool For Finishing

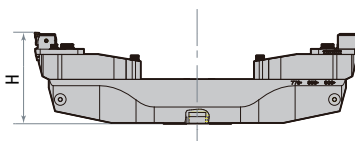
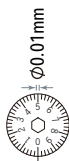

Specification		Boring range	H	Adapter size	B-Boring range	Work depth	Insert	Weight
FMX	CBH538795	538-795	197	FMX	413-670	25	TCMT1102	25.64
	CBH7781035	778-1035	217	FMX	653-910	25	/	36.83
	CBH10181275	1018-1275	217	FMX	893-1150	25	TPGH1103	44.26

Insert holder	Picture	Insert	Screw	Wrench	Weight
CBH5-1-TC-V		TCMT1102	M025W060	Q08	0.04
CBH5-1-TP-V		TPGH1103	M030W070	Q08	0.04

Item	Specification	Picture	Weight
Adapter size	HSK-A-FMX		-
	BT-FMX		-
	SK-FMX		-
	BBT-FMX		-
	CAT-FMX		-
Extension aluminum bridge	FMX40-538		14.77
	FMX40-778		25.96
	FMX40-1018		33.39
Long aluminum sider	FMA35-S24		3.35
Finish boring slider	FMA34-S24		1.02
Finish boring head	A34-CBH5395		0.55
Balancing weight	FMA34-S24-PZK		1.56

### Feature

1. 70-90% of material is made from Aluminum.
2. With internal cooling supply.
3. Balanced: G6.3;1,000 rpm.



# CBH-M

## Boring Tool For Pin Turning

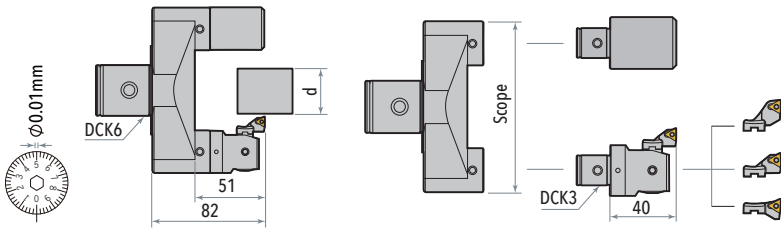

Specification	Ø d Range	Bridge frame	DCK Side-lock screw	Boring head	Balance weight	Insert holder	Insert	Boring range	Weight	
DCK6-CBH	24-34-M	24-34	DCK6-2452-42 114	M120Z200-30P-D	CBH32-60	DCK3-CBH	CBH3-3	TPGH0802	134-144	1.60
	33-43-M	33-43			CBH32-60	DCK3-CBH	CBH3-2	TPGH0802	125-135	1.60
	42-52-M	42-52			CBH32-60	DCK3-CBH	CBH3-1	TPGH0802	116-126	1.60
	52-62-M	52-62	DCK6-5280-42 142	M120Z200-30P-D	CBH32-60	DCK3-CBH	CBH3-3	TPGH0802	162-172	1.80
	61-71-M	61-71			CBH32-60	DCK3-CBH	CBH3-2	TPGH0802	153-163	1.80
	70-80-M	70-80			CBH32-60	DCK3-CBH	CBH3-1	TPGH0802	144-154	1.80
	80-90-M	80-90	DCK6-80108-42 170	M120Z200-30P-D	CBH32-60	DCK3-CBH	CBH3-3	TPGH0802	190-200	2.00
	89-99-M	89-99			CBH32-60	DCK3-CBH	CBH3-2	TPGH0802	181-191	2.00
98-108-M	98-108	CBH32-60			DCK3-CBH	CBH3-1	TPGH0802	172-182	2.00	

Notice: 1. Boring head have only one cartridge, without insert, please order them separately.  
 2. Anti-clockwise spindle rotation required.

### Feature

1. CBH boring head loaded opposite direction can process boring machining.
2. Machining range  $\phi 116 - \phi 200$ .



## MICRO BORING

### CBH-L

#### Boring Tool For Pin Turning (Large Diameter)

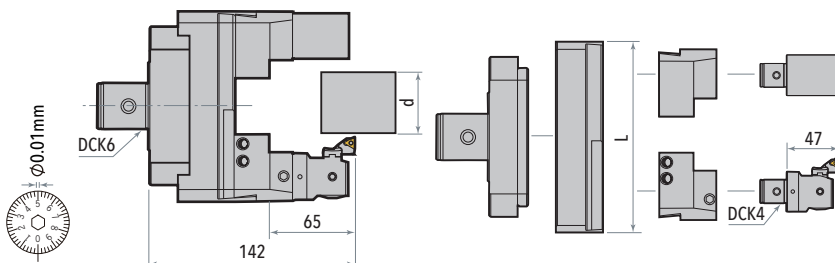

Specification	Ød Range	Flange adapter	Extention bridge	L	Balance weight	Boring head	Boring range	Boring depth	Finish head	Weight	
DCK6-CBH	13-115-L	13-115	DCK6-FL200	DST200	180	DCK4-CB200	CBH41-74 (CBH4-1) TCMT 1102 (With) TPGH 1103 (For choice)	108-192	75, Φ<180	DCK4-CBH	8.70
	112-215-L	112-215	DCK6-FL200	DST300	280	DCK4-CB200		108-292	75, Φ<280	DCK4-CBH	10.02
	212-315-L	212-315	DCK6-FL200	DST400	380	DCK4-CB200		108-392	75, Φ<380	DCK4-CBH	11.92
	312-415-L	312-415	DCK6-FL200	DST500	480	DCK4-CB200		108-492	75, Φ<480	DCK4-CBH	13.82
	412-515-L	412-515	DCK6-FL200	DST600	580	DCK4-CB200		108-592	75, Φ<580	DCK4-CBH	15.72
	512-615-L	512-615	DCK6-FL200	DST700	680	DCK4-CB200		108-692	75, Φ<680	DCK4-CBH	17.7
612-715-L	612-715	DCK6-FL200	DST800	780	DCK4-CB200	108-792	75, Φ<780	DCK4-CBH	19.60		

#### M080U100-D

Notice: 1. Boring head with one cartridge, without insert, please order it separately.

2. Anti-clockwise spindle rotation required.

# MICRO BORING



## DBJ10/12/16 Micro-boring Head

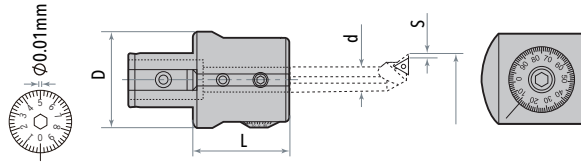

Specification	D	d	L	S Micro distance	Dial precision	Boring range	Adapter size	Adjusting screw	Locking screw	Wrench	Weight
DBJ10	39	10	30	2.5	0.01	6-24	DCK4	M060U060-D	M060U050	T03	0.50
DBJ12	50	12	40	4	0.01	6-32	DCK5	M080U090-D	M080U060	T04	0.75
DBJ16	64	16	50	5	0.01	8-50	DCK6	M100U110-D	M100U070	T05	1.14

## DBJ10 Micro-boring Bar

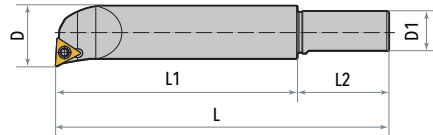

Specification	D	D1	L1	L2	L	Boring range	Insert	Insert screw	Wrench	Weight	
DBJ	1006-24	6	10	24	32	64	6-8	WBGTO601	M020W040	Q06	0.03
	1008-32	8	10	32	32	64	8-10	TBGT0601	M020W040	Q06	0.04
	1010-40	10	10	40	32	72	10-12	TBGT0601	M020W040	Q06	0.05
	1012-45	12	10	45	32	77	12-16	TPGH0902	M025W060	Q08	0.06
	1016-45	16	10	45	32	77	16-20	TPGH0902	M025W060	Q08	0.08
	1020-45	20	10	45	32	77	20-24	TPGH0902	M025W060	Q08	0.11

## DBJ12 Micro-boring Bar

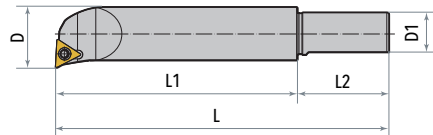

Specification	D	D1	L1	L2	L	Boring range	Insert	Insert screw	Wrench	Weight	
DBJ	1206-24	6	12	24	32	64	6-8	WBGTO601	M020W040	Q06	0.03
	1208-32	8	12	32	32	64	8-10	TBGT0601	M020W040	Q06	0.04
	1210-40	10	12	40	32	72	10-12	TBGT0601	M020W040	Q06	0.05
	1212-45	12	12	45	32	77	12-16	TPGH0902	M025W060	Q08	0.06
	1216-45	16	12	45	32	77	16-20	TPGH0902	M025W060	Q08	0.09
	1220-45	20	12	45	32	77	20-25	TPGH0902	M025W060	Q08	0.12
	1225-45	25	12	45	32	77	25-32	TPGH1103	M030W070	Q08	0.16



## MICRO BORING

### DBJ16 Micro-boring Bar

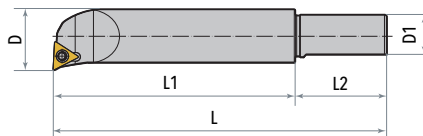

Specification	D	D1	L1	L2	L	Boring range	Insert	Insert screw	Wrench	Weight	
DBJ	1606-24	6	16	24	34	66	6-8	WBGTO601	M020W040	Q06	0.06
	1608-32	8	16	32	34	76	8-111	TBGT0601	M020W040	Q06	0.07
	1610-40	10	16	40	34	77	10-13	TBGT0601	M020W040	Q06	0.07
	1612-53	12	16	53	34	90	12-17	TPGH0902	M025W060	Q08	0.09
	1616-68	16	16	68	34	102	16-21	TPGH0902	M025W060	Q08	0.13
	1620-83	20	16	83	34	120	20-26	TPGH1103	M030W070	Q08	0.20
	1625-90	25	16	90	34	124	25-32	TPGH1103	M030W070	Q08	0.25
	1630-90	30	16	90	34	124	30-42	TPGH1103	M030W070	Q08	0.25
	1640-90	40	16	90	34	124	40-50	TPGH1103	M030W070	Q08	0.26

### DBJ Micro-boring Tool Kit

DBJ10-6PCS	Specification			Specification	Boring range	Adapter	Weight
	DBJ1006-24	DBJ1010-40	DBJ1016-45				
	DBJ1008-32	DBJ1012-45	DBJ1020-45	BT40-DBJ10-6PCS	6-24	BT40-DCK4-70	2.20
				BT50-DBJ10-6PCS	6-24	BT50-DCK4-100	4.72

#### Items Included

1. One boring adapter
2. One micro boring head
3. Six micro boring bars
4. Three wrenches

DBJ12-7PCS	Specification				Specification	Boring range	Adapter	Weight
	DBJ1206-24	DBJ1210-40	DBJ1216-45	DBJ1225-45				
	DBJ1208-32	DBJ1212-45	DBJ1220-45		BT40-DBJ12-7PCS	6-32	BT40-DCK5-60	2.40
					BT50-DBJ12-7PCS	6-32	BT50-DCK5-90	4.94

#### Items Included

1. One boring adapter
2. One micro boring head
3. Seven micro boring bars
4. Three wrenches

DBJ16-8PCS	Specification				Specification	Boring range	Adapter	Weight
	DBJ1608-32	DBJ1612-53	DBJ1620-83	DBJ1630-90				
	DBJ1610-40	DBJ1616-68	DBJ1625-90	DBJ1640-90	BT40-DBJ16-8PCS	8-50	BT40-DCK6-55	3.68
					BT50-DBJ16-8PCS	8-50	BT50-DCK6-85	6.74

#### Items Included

1. One boring adapter
2. One micro boring head
3. Eight micro boring bars
4. Three wrenches



**DBJ**  
Collet For Solid Carbide Boring Bar

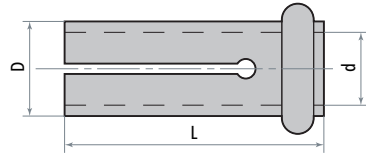

Specification	D	d	L	Rubber washer	Boring bar	
DBJ	10-6	10	6	26	Φ8*Φ1.5	CA06**
	10-8	10	8	26	Φ8*Φ1.5	DT08-M5-*
	12-8	12	8	32	Φ10*Φ1.5	DT08-M5-*
	12-10	12	10	32	Φ10*Φ1.5	DT10-M6-*
	16-8	16	8	38	Φ14*Φ1.5	DT08-M5-*
	16-10	16	10	38	Φ14*Φ1.5	DT10-M6-*
	16-12	16	12	38	Φ14*Φ1.5	DT12-M6-*

**DT**  
Solid Carbide Boring Bar

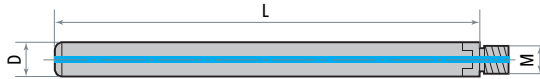

Specification	D	L	M	Inser holder	Collect	Weight	
DT	08-M5-110	8	110	M5	DEB09,DEB10.5	DBJ16-8	0.074
	10-M6-110	10	110	M6	DEB12	DBJ16-10	0.118
	10-M6-135	10	135	M6	DEB12	DBJ16-10	0.149
	10-M6-150	10	150	M6	DEB12	DBJ16-10	0.172
	12-M6-120	12	120	M6	DEB14,DEB16	DBJ16-12	0.178
	12-M6-140	12	140	M6	DEB14,DEB16	DBJ16-12	0.205
	12-M6-160	12	160	M6	DEB14,DEB16	DBJ16-12	0.245
	16-M10-125	16	125	M10	DEB18,DEB20,DEB22,DEB24,DEB26,DEB28, DEB30,DEB32,DEB34,DEB36,DEB38,DEB40, DEB42,DEB44,DEB46,DEB48,DEB50	-	0.310
	16-M10-160	16	160	M10		-	0.129
	16-M10-200	16	200	M10		-	0.506
						-	0.506



## MICRO BORING

### DEB Insert Bar

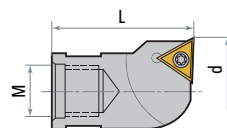

Specification	d	L	M	Boring range	Insert	Insert screw	Wrench	Weight	
DEB	09	9	18	M5	9-10.5	TPGH0802	M022W050	Q07	0.03
	10.5	10.5	18	M5	10.5-12	TPGH0802	M022W050	Q07	0.03
	12	12	23	M6	12-14	TPGH0802	M022W050	Q07	0.03
	14	14	23	M6	14-16	TPGH0802	M022W050	Q07	0.03
	16	16	23	M6	16-18	TPGH0802	M022W050	Q07	0.04
	18	18	27	M10	18-20	TPGH0802	M022W050	Q07	0.04
	20	20	27	M10	20-22	TPGH0802	M022W050	Q07	0.05
	22	22	27	M10	22-24	TPGH0802	M022W050	Q07	0.05
	24	24	27	M10	24-26	TPGH0802	M022W050	Q07	0.05
	26	26	27	M10	26-28	TPGH0802	M022W050	Q07	0.05
	28	28	27	M10	28-30	TPGH0802	M022W050	Q07	0.06
	30	30	27	M10	30-32	TPGH0802	M022W050	Q07	0.06
	32	32	27	M10	32-34	TPGH0802	M022W050	Q07	0.07
	34	34	27	M10	34-36	TPGH0802	M022W050	Q07	0.09
	36	36	27	M10	36-38	TPGH0802	M022W050	Q07	0.11
	38	38	27	M10	38-40	TPGH0802	M022W050	Q07	0.15
	40	40	27	M10	40-42	TPGH0802	M022W050	Q07	0.16
	42	42	27	M10	42-44	TPGH0802	M022W050	Q07	0.19
44	44	27	M10	44-46	TPGH0802	M022W050	Q07	0.22	
46	46	27	M10	46-48	TPGH0802	M022W050	Q07	0.26	
48	48	27	M10	48-50	TPGH0802	M022W050	Q07	0.30	
50	50	27	M10	50-52	TPGH0802	M022W050	Q07	0.34	

# MICRO BORING



## NBH2084 Micro-boring Head

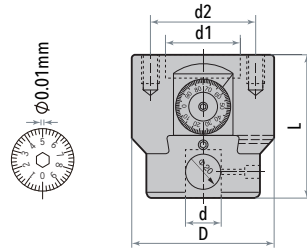

Specification	D	d	d1	d2	L	Boring range	Micro distance	Dial precision	Adapter size	Weight
NBH2084	84	20	35	60	80	8-280	28	0.01	NBH-AB	2.74
						Adjusting screw	Wrench	Locking screw	Wrench	
						M080U160-D	T04	M120U140	T06	

## DBJ20 Micro-boring Head

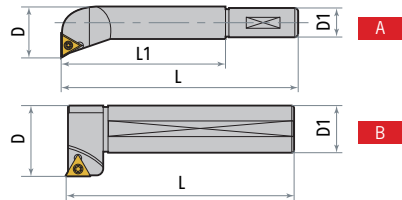

Specification	Figure	D	D1	L1	L	Boring range	Insert	Insert screw	Wrench	Weight	
DBJ	2008-32	A	8	20	32	74	8-11	TBGT0601	M020W040	Q06	0.09
	2010-40	A	10	20	40	75	10-13	TBGT0601	M020W040	Q06	0.10
	2012-53	A	12	20	53	88	12-17	TPGH0902	M025W060	Q08	0.12
	2016-68	A	16	20	68	103	16-21	TPGH0902	M025W060	Q08	0.16
	2020-83	A	20	20	83	115	20-26	TPGH1103	M030W070	Q08	0.22
	2025-96	A	25	20	96	131	25-135	TPGH1103	M030W070	Q08	0.35
	2030-115	A	30	20	115	159	30-140	TPGH1103	M030W070	Q08	0.52
	20120-97	B	30	20	-	97	120-280	TPGH1103	M030W070	Q08	0.25

## NBH2084 Micro-Boring Tool Kit

DBJ20-8PCS	Specification				Specification	Boring range	Adapter	Weight
	DBJ2008-32	DBJ2012-53	DBJ2020-83	DBJ2030-115	BT40-NBH2084-8PCS	8-280	BT40-NBH-A50	6.44
DBJ2010-40	DBJ2016-68	DBJ2025-96	DBJ20120-97	BT50-NBH2084-8PCS	8-280	BT50-NBH-A50	8.89	

### Items Included

1. One boring adapter
2. One micro boring head
3. Eight micro boring bars
4. Four wrenches



## ROUGH BORING

### ABH Rough Boring Tool

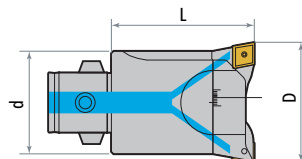

Specification	d	L	Boring range	Adapter size	Insert holder		Weight
DCK1-ABH19-M	19	32.5	20-26	DCK1	AACC2026	AACC2026	0.09
DCK1-ABH19-L	19	32.5	25-31	DCK1	AACC2531	AACC2531	0.10
DCK2-ABH25-M	25	50.6	29-36	DCK2	AACC2936	AACC2936	0.17
DCK2-ABH25-L	25	50.6	35-42	DCK2	AACC3542	AACC3542	0.19
DCK3-ABH32-M	32	62.5	36-45	DCK3	AACC3645	AACC3645	0.37
DCK3-ABH32-L	32	62.5	44-53	DCK3	AACC4453	AACC4453	0.37
DCK4-ABH40-M	40	62.5	45-56	DCK4	AACC4556	AACC4556	0.56
DCK4-ABH40-L	40	62.5	55-66	DCK4	AACC5566	AACC5566	0.58
DCK5-ABH50-M	50	78.5	56-74	DCK5	AACC5674	AACC5674	1.10
DCK5-ABH50-L	50	78.5	74-92	DCK5	AACC7492	AACC7492	1.14
DCK6-ABH63-M	64	81.4	70-90	DCK6	AACC7090	AACC7090	1.78
DCK6-ABH63-L	64	81.4	90-110	DCK6	AACC90110	AACC90110	1.90
DCK6-ABH80-M	80	81.4	90-130	DCK6	AACC90130	AACC90130	2.30
DCK6-ABH80-L	80	81.4	130-170	DCK6	AACC130170	AACC130170	2.44



## ABH Rough Back-boring Tool

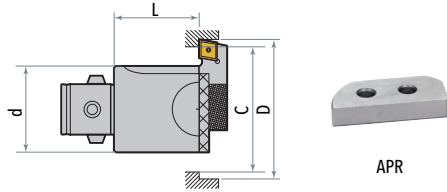

Specification	d	L	Boring range	Adapter size	Insert holder	Weight	Weight
DCK2-ABH25-MF	25	41	29-36	DCK2	AACC2936	APR25	0.17
DCK2-ABH25-LF	25	41	35-42	DCK2	AACC3542	APR25	0.18
DCK3-ABH32-MF	32	53	36-45	DCK3	AACC3645	APR32	0.36
DCK3-ABH32-LF	32	53	44-53	DCK3	AACC4453	APR32	0.36
DCK4-ABH40-MF	40	49	45-56	DCK4	AACC4556	APR40	0.54
DCK4-ABH40-LF	40	49	55-66	DCK4	AACC5566	APR40	0.55
DCK5-ABH50-MF	50	63	56-74	DCK5	AACC5674	APR50	1.07
DCK5-ABH50-LF	50	63	74-92	DCK5	AACC7492	APR50	1.09
DCK6-ABH63-MF	64	61	70-90	DCK6	AACC7090	APR63	1.74
DCK6-ABH63-LF	64	61	90-110	DCK6	AACC90110	APR63	1.79
DCK6-ABH80-MF	80	61	90-130	DCK6	AACC90130	APR80	2.23
DCK6-ABH80-LF	80	61	130-170	DCK6	AACC130170	APR80	2.30

## ABH Twin-bit Rough Boring Head

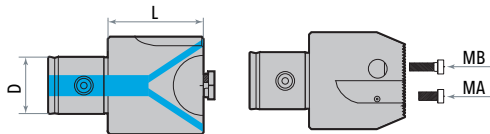

Specification	D	L	MA	MB	Wrench	Weight	
ABH	19	11	21.5	-	E040U160-D	L03	0.07
	25	14	40	-	E040U160-D	L03	0.16
	32	18	48	E050U120-D	E050U200-D	L04	0.33
	40	22	48	E060U120-D	E060U200-D	L05	0.49
	50	28	60	E060U160-D	E060U250-D	L05	0.98
	63	36	60	E080U160-D	E080U300-D	L06	1.60
	80	36	60	E080U160-D	E080U300-D	L06	1.93



## ROUGH BORING

### ABH

#### Cartridge For ABH Rough Boring Tool

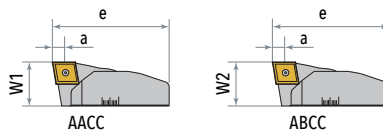

Cartridge A	Cartridge B	W1	W2	e	a	Boring range	Boring head	Insert	Insert screw	Wrench	Weight		
AACC	2026	ABCC	2026	11.95	11.85	17.7	0.5-3	20-26	ABH19	CCMT0602	M025W060	Q08	0.01
	2531		2531	11.95	11.85	20.2	0.5-3	25-31	ABH19	CCMT0602	M025W060	Q08	0.01
	2936		2936	11.7	11.5	25	0.5-3	29-36	ABH40	CCMT0602	M025W060	Q08	0.01
	3542		3542	11.7	11.5	30	0.5-3	35-42	ABH40	CCMT0602	M025W060	Q08	0.02
	3645		3645	11.7	11.5	32	0.5-3	36-45	ABH50	CCMT0602	M025W060	Q08	0.02
	4453		4453	11.7	11.5	38	0.5-3	44-53	ABH50	CCMT0602	M025W060	Q08	0.02
	4556		4556	15.6	15.4	40	0.5-4	45-56	ABH63	CCMT09T3	M040S100-1	Q15	0.04
	5566		5566	15.6	15.4	46.5	0.5-4	55-66	ABH63	CCMT09T3	M040S100-1	Q15	0.05
	5674		5674	19.2	19	49	0.5-4	56-74	ABH80	CCMT09T3	M040S100-1	Q15	0.06
	7492		7492	19.2	19	62	0.5-4	74-92	ABH80	CCMT09T3	M040S100-1	Q15	0.09
	7090		7090	22.6	22.4	60	0.5-5	70-90	ABH25	CCMT1204	M050Y110-1	Q20	0.12
	90110		90110	22.6	22.4	78	0.5-5	90-110	ABH25	CCMT1204	M050Y110-1	Q20	0.18
	90130		90130	22.6	22.4	82	0.5-5	90-130	ABH32	CCMT1204	M050Y110-1	Q20	0.18
	130170		130170	22.6	22.4	99.5	0.5-5	130-170	ABH32	CCMT1204	M050Y110-1	Q20	0.23

### ABH

#### Cartridge for ABH Rough Back-boring Tool

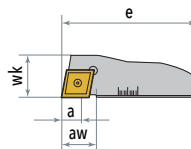

Cartridge K	aw	wk	e	a	Boring range	Boring head	Insert	Insert screw	Wrench	Weight	
AKCC	2936	4	11	25	0.5-3	29-36	ABH25	CCMT0602	M025W060	Q08	0.01
	3542	7	11	30	0.5-3	35-42	ABH25	CCMT0602	M025W060	Q08	0.02
	3645	5	11	32	0.5-3	36-45	ABH32	CCMT0602	M025W060	Q08	0.02
	4453	9	11	38	0.5-3	44-53	ABH32	CCMT0602	M025W060	Q08	0.02
	4556	5	15	40	0.5-4	45-56	ABH40	CCMT09T3	M040S100-1	Q15	0.04
	5566	12	15	46.5	0.5-4	55-66	ABH40	CCMT09T3	M040S100-1	Q15	0.05
	5674	11	17	19	0.5-4	56-74	ABH50	CCMT09T3	M040S100-1	Q15	0.06
	7492	17	17	62	0.5-4	74-92	ABH50	CCMT09T3	M040S100-1	Q15	0.09
	7090	12	12	60	0.5-5	70-90	ABH63	CCMT1204	M050Y110-1	Q20	0.13
	90110	22	22	78	0.5-5	90-110	ABH63	CCMT1204	M050Y110-1	Q20	0.18
	90130	24	24	82	0.5-5	90-130	ABH80	CCMT1204	M050Y110-1	Q20	0.18
	130170	24	24	102.5	0.5-5	130-170	ABH80	CCMT1204	M050Y110-1	Q20	0.25



**DBH**  
Rough Boring Tool

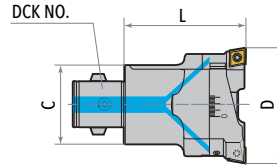

Specification	C	L	Boring range	Adapter size	Cartridge		Weight
DCK1-DBH20-26-C	19	32.5	20-26	DCK1	DACC2026-C	DACC2026-C	0.06
DCK2-DBH25-33-C	24	32.5	25-33	DCK2	DACC2533-C	DACC2533-C	0.12
DCK3-DBH32-42-T	31	40	32-42	DCK3	DACC3242-T	DACC3242-T	0.27
DCK3-DBH32-42-C	31	40	32-42	DCK3	DACC3242-C	DACC3242-C	0.25
DCK4-DBH40-55-T	39	47	40-55	DCK4	DACC4055-T	DACC4055-T	0.49
DCK4-DBH40-55-C	39	47	40-55	DCK4	DACC4055-C	DACC4055-C	0.45
DCK5-DBH52-70-T	50	57	52-70	DCK5	DACC5270-T	DACC5270-T	0.88
DCK5-DBH52-70-C	50	57	52-70	DCK5	DACC5270-C	DACC5270-C	0.88
DCK6-DBH68-92-T	64	71	68-92	DCK6	DACC6892-T	DACC6892-T	1.60
DCK6-DBH68-92-C	64	71	68-92	DCK6	DACC6892-C	DACC6892-C	1.58
DCK6-DBH90-122-T	64	71	90-122	DCK6	DACC90122-T	DACC90122-T	2.43
DCK6-DBH90-122-C	64	71	90-122	DCK6	DACC90122-C	DACC90122-C	2.28
DCK6-DBH120-164-T	64	71	120-164	DCK6	DACC120164-T	DACC120164-T	3.20
DCK6-DBH120-164-C	64	71	120-164	DCK6	DACC120164-C	DACC120164-C	3.20
DCK6-DBH160-204-T	64	71	160-204	DCK6	DACC160204-T	DACC160204-T	3.30
DCK6-DBH160-204-C	64	71	160-204	DCK6	DACC160204-C	DACC160204-C	3.30
DCK7-DBH120-164-T	90	87	120-164	DCK7	DACC120164-T	DACC120164-T	4.70
DCK7-DBH120-164-C	90	87	120-164	DCK7	DACC120164-C	DACC120164-C	4.70
DCK7-DBH160-204-T	90	87	160-204	DCK7	DACC160204-T	DACC160204-T	5.80
DCK7-DBH160-204-C	90	87	160-204	DCK7	DACC160204-C	DACC160204-C	5.80







## ROUGH BORING

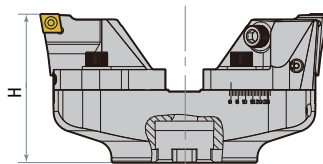

### FM-DBH

#### Large Diameter Rough Boring Tool



Specification	Boring range	H	Adapter size	Insert	Weight	
FMS	DBH148200	148-200	102	FMS	CCMT1204	3.86
	DBH198250	198-250	102	FMS	/	4.39
	DBH248300	248-300	102	FMS	CNMG1606	4.87

Insert holder	Picture	Insert	Item	Wrench	Weight
S12-R40-CC12		CCMT1204	 M050Y110-1	Q20	0.25
S12-R40-CN16		CNMG1606	 MC1604 MX0822 MY0823 ML0828	L03,L04	0.30

Item	Specification	Picture	Weight
Adapter size	HSK-A-FMS		-
	BT-FMS		-
	SK-FMS		-
	BBT-FMS		-
	CAT-FMS		-
Extension aluminum bridge	FMS40-148		1.46
	FMS40-198		1.99
	FMS40-240		2.47
Rough boring slider	FMS12-S17		0.95

### Feature

1. 70-90% of material is made from Aluminum.
2. With internal cooling supply.
3. Axial direction adjustable 0~1.5mm.
4. Balanced: G6.3;1,000 rpm.



## FM-DBH

### Large Diameter Rough Boring Tool

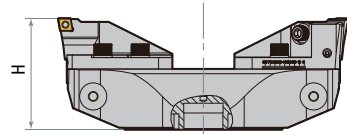

Specification		Boring range	H	Adapter size	Insert	Weight
FMX	DBH298380	298-380	114	FMX	CCMT1204	8.97
	DBH378460	378-460	119	FMX	/	10.73
	DBH458540	458-540	124	FMX	CNMG1606	12.66

Insert holder	Picture	Insert	Item	Wrench	Weight
S12-R40-CC12		CCMT1204	M050Y110-1	Q20	0.25
S12-R40-CN16		CNMG1606	MC1604 MX0822 MY0823 ML0828	L03,L04	0.30

Item	Specification	Picture	Weight
Adapter size	HSK-A-FMX		-
	BT-FMX		-
	SK-FMX		-
	BBT-FMX		-
	CAT-FMX		-
Extension aluminum bridge	FMX40-298		5.33
	FMX40-378		7.09
	FMX40-458		9.02
Rough boring slider	FMS12-S24		1.57

### Feature

1. 70-90% of material is made from Aluminum.
2. With internal cooling supply.
3. Axial direction adjustable 0~1.5mm.
4. Balanced: G6.3;1,000 rpm.





## ROUGH BORING



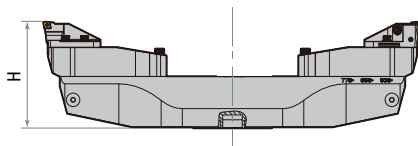

### FM-DBH

#### Large Diameter Rough Boring Tool

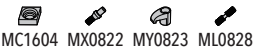

Specification	Boring range	H	Adapter size	Insert	Weight	
FMX	DBH538780	538-780	198	FMX	CCMT1204	25.11
	DBH7781020	778-1020	218	FMX	/	36.30
	DBH10181260	1018-1260	218	FMX	CNMG1606	43.73

Insert holder	Picture	Insert	Item	Wrench	Weight
S12-R40-CC12		CCMT1204	 M050Y110-1	Q20	0.25
S12-R40-CN16		CNMG1606	 MC1604 MX0822 MY0823 ML0828	L03,L04	0.30

Item	Specification	Picture	Weight
Adapter size	HSK-A-FMX		-
	BT-FMX		-
	SK-FMX		-
	BBT-FMX		-
	CAT-FMX		-
Extension aluminum bridge	FMX40-538		14.77
	FMX40-778		25.96
	FMX40-1018		33.39
Long aluminum slider	FMA35-S24		3.35
Rough boring slider	FMS12-S24		1.57

### Feature

1. 70-90% of material is made from Aluminum.
2. With internal cooling supply.
3. Axial direction adjustable 0~1.5mm.
4. Balanced: G6.3;1,000 rpm.



## BSA 45° Boring Holder With Square Boring Bit

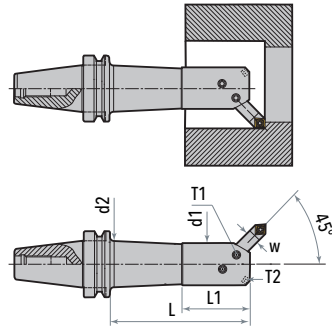

Specification	d1	d2	L1	L	Boring range	W	T1	T2	Weight		
BT-40	BSA25-120	20	22	35	90	25-38	8	M060U060-D	-	1.19	
	BSA30-150	24	26	40	120	30-42	8	M060U080-D	M060U100-D	1.40	
	BSA38-165	30	33	50	135	38-52	10	M080U100-D	M080U120-D	1.70	
	BSA42-165	34	37	50	135	42-56	10	M080U100-D	M080U120-D	1.91	
	BSA42-210	34	37	50	180	42-56	10	M080U100-D	M080U120-D	2.24	
	BSA50-165	40	44	65	135	50-65	13	M080U100-D	M080U120-D	M080U160-D	2.24
	BSA62-180	50	56	80	150	62-90	16	M100U120-D	M100U160-D	M100U200-D	3.20
	BSA72-180	60	-	95	150	72-110	19	M100U120-D	M100U200-D	M100U250-D	3.93
	BSA90-180	75	-	-	150	90-125	19	M120U200-D	M120U300-D	-	5.13
BT-50	BSA25-135	20	22	35	92	25-38	8	M060U060-D	-	3.90	
	BSA30-165	24	26	40	122	30-42	8	M060U080-D	M060U100-D	4.07	
	BSA38-180	30	33	50	137	38-52	10	M080U100-D	M080U120-D	4.39	
	BSA42-210	34	37	60	167	42-56	10	M080U100-D	M080U120-D	4.86	
	BSA50-180	40	44	65	137	50-65	13	M080U100-D	M080U120-D	M080U160-D	5.00
	BSA50-240	40	44	65	197	50-65	13	M080U100-D	M080U120-D	M080U160-D	5.59
	BSA62-195	50	56	80	152	62-90	16	M100U120-D	M100U160-D	M100U200-D	5.93
	BSA62-270	50	56	80	227	62-90	16	M100U120-D	M100U160-D	M100U200-D	6.63
	BSA72-195	60	66	95	152	72-110	19	M100U160-D	M100U200-D	M100U250-D	6.18
	BSA72-285	60	66	95	242	72-110	19	M100U160-D	M100U200-D	M100U250-D	8.92
	BSA90-210	75	80	110	267	90-125	19	M120U200-D	M120U300-D	-	8.88
	BSA90-300	75	80	110	257	90-125	19	M120U200-D	M120U300-D	-	12.14
	BSA105-195	90	-	-	152	105-160	25	M120U200-D	M120U300-D	-	10.60
	BSA105-285	90	94	130	242	105-160	25	M120U200-D	M120U300-D	-	14.00

### Feature

1. Can be with 4-corner welded cutter or indexable cutting tools.
2. Special for blind holes.



## ROUGH BORING

### BSB 90°

#### Boring Holder With Square Boring Bit

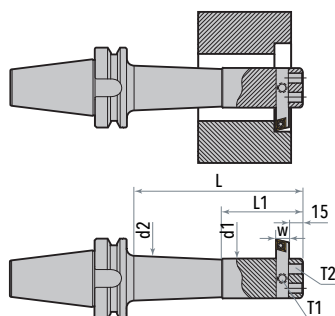

Specification	d1	d2	L1	L	Boring range	W	T1	T2	Weight	
BT-40	BSB25-120	20	22	35	90	25-52	8	M060U060-D	M060U120-D	1.21
	BSB38-150	30	33	55	120	38-70	10	M080U100-D	M080U120-D	1.73
	BSB50-165	40	44	70	135	50-90	13	M100U120-D	M100U120-D	2.45
	BSB62-180	50	56	80	150	62-115	16	M100U120-D	M100U160-D	3.56
	BSB90-180	75	-	-	150	90-150	19	M120U120-D	M120U250-D	6.30
BT-50	BSB25-135	20	22	35	92	25-52	8	M060U060-D	M060U120-D	3.95
	BSB38-180	30	33	55	137	38-70	10	M080U100-D	M080U120-D	4.51
	BSB50-180	40	44	70	137	50-90	13	M100U120-D	M100U120-D	5.21
	BSB50-240	40	44	70	197	50-90	13	M100U120-D	M100U120-D	5.82
	BSB62-195	50	56	80	152	62-115	16	M100U120-D	M100U160-D	6.33
	BSB62-270	50	56	80	227	62-115	16	M100U120-D	M100U160-D	7.61
	BSB72-195	60	66	95	152	72-135	19	M120U120-D	M120U200-D	7.40
	BSB72-285	60	66	95	242	72-135	19	M120U120-D	M120U200-D	9.37
	BSB90-210	75	80	115	167	90-150	19	M120U120-D	M120U250-D	9.97
	BSB90-300	75	80	115	257	90-150	19	M120U120-D	M120U250-D	13.24
	BSB105-195	90	-	-	152	105-190	25	M120U120-D	M120U300-D	11.66
	BSB105-285	90	94	135	242	105-190	25	M120U120-D	M120U300-D	16.29

### Feature

1. For work piece with a rough surface.
2. Special for through holes.



## TBS Square Boring Bar

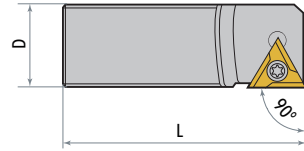

T90° For BSB Boring Holder

Specification	D	L	Boring range	Insert	Insert screw	Wrench	Weight	
TBS	910-36-L	10	35	38-50	TPGH0902	M025W060	Q08	0.05
	910-45-L	10	45	50-70	TPGH0902	M025W060	Q08	0.05
	913-48-L	13	48	50-70	TPGH1103	M030W070	Q08	0.08
	913-65-L	13	65	70-90	TPGH1103	M030W070	Q08	0.10
	916-60-L	16	60	62-90	TPGH1103	M030W070	Q08	0.15
	916-80-L	16	80	90-115	TPGH1103	M030W070	Q08	0.20
	919-70-L	19	70	72-105	TPGH1603	M035D080-2	Q15	0.22
	919-85-L	19	85	90-115	TPGH1603	M035D080-2	Q15	0.25
	919-90-L	19	90	105-135	TPGH1603	M035D080-2	Q15	0.27
	919-105-L	19	105	115-150	TPGH1603	M035D080-2	Q15	0.30
	925-100-L	25	100	105-140	TPGH1603	M035D080-2	Q15	0.50
	925-135-L	25	130	140-190	TPGH1603	M035D080-2	Q15	0.65

## TBS Square Boring Bar

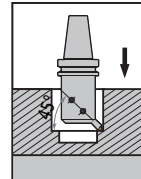
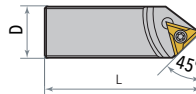

T45° For BSA Boring Holder

Specification	D	L	Boring range	Insert	Insert screw	Wrench	Weight	
TBS	410-45	10	45	38-52	TPGH0902	M025W060	Q08	0.05
	410-50	10	50	42-56	TPGH0902	M025W060	Q08	0.05
	413-60	13	60	50-65	TPGH1103	M030W070	Q08	0.10
	416-75	16	75	62-90	TPGH1103	M030W070	Q08	0.15
	419-90	19	90	72-110	TPGH1603	M035D080-2	Q15	0.25
	419-115	19	115	90-125	TPGH1603	M035D080-2	Q15	0.35
	425-130	25	130	105-160	TPGH1603	M035D080-2	Q15	0.65

### Feature

1. For roughing and medium-heavy cutting.



## ROUGH BORING

### CBS

#### Square Boring Bar

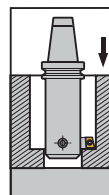
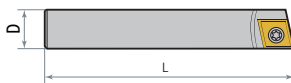

C90° For BSB Boring Holder

Specification	D	L	Boring range	Insert	Insert screw	Wrench	Weight	
CBS	908-23-L	8	23	25-38	CCMT0602	M025W060	Q08	0.05
	908-30-L	8	30	38-52	CCMT0602	M025W060	Q08	0.06
	910-36-L	10	36	38-50	CCMT0602	M025W060	Q08	0.07
	910-45-L	10	45	50-70	CCMT0602	M025W060	Q08	0.08
	913-48-L	13	48	50-70	CCMT09T3	M040S100	Q15	0.10
	913-65-L	13	65	70-90	CCMT09T3	M040S100	Q15	0.12
	916-60-L	16	60	662-90	CCMT09T3	M040S100	Q15	0.15
	916-80-L	16	80	90-115	CCMT09T3	M040S100	Q15	0.17
	919-70-L	19	70	72-105	CCMT1204	M050Y110-1	Q20	0.20
	919-85-L	19	85	90-115	CCMT1204	M050Y110-1	Q20	0.23
	919-90-L	19	90	105-135	CCMT1204	M050Y110-1	Q20	0.24
	919-105-L	19	105	115-150	CCMT1204	M050Y110-1	Q20	0.30
	925-100-L	25	100	105-140	CCMT1204	M050Y110-1	Q20	0.50
	925-135-L	25	135	140-190	CCMT1204	M050Y110-1	Q20	0.65

### CBS

#### Square Boring Bar

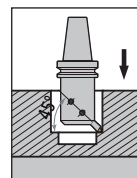
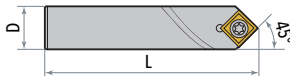

C45° For BSA Boring Holder

Specification	D	L	Boring range	Insert	Insert screw	Wrench	Weight	
CBS	408-30	8	30	25-38	CCMT0602	M025W060	Q08	0.05
	408-35	8	35	30-42	CCMT0602	M025W060	Q08	0.06
	410-45	10	45	38-52	CCMT0602	M025W060	Q08	0.07
	410-50	10	50	42-56	CCMT0602	M025W060	Q08	0.08
	413-60	13	60	50-65	CCMT09T3	M040S100	Q15	0.10
	416-75	16	75	62-90	CCMT09T3	M040S100	Q15	0.20
	419-90	19	90	72-110	CCMT1204	M050Y110-1	Q20	0.25
	419-115	19	115	90-125	CCMT1204	M050Y110-1	Q20	0.30
	425-130	25	130	105-160	CCMT1204	M050Y110-1	Q20	0.60

#### Feature

1. For heavy cutting.



## SB

### Fixed Rough Boring Bar

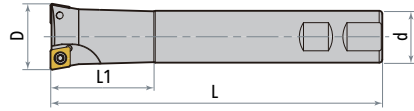

Specification	Teeth	D	d	L1	L	Insert	Insert screw	Wrench	Weight
SB- C16-TB16-110	2	15.8	16	60	110	CCMT060204	M025W060	Q08	0.15
C16-TB16-135	2	15.8	16	85	135	CCMT060204	M025W060	Q08	0.18
C16-TB17-110	2	16.8	16	40	110	CCMT060204	M025W060	Q08	0.16
C16-TB17-135	2	16.8	16	40	135	CCMT060204	M025W060	Q08	0.20
C16-TB18-110	2	17.8	16	40	110	CCMT060204	M025W060	Q08	0.16
C16-TB18-135	2	17.8	16	40	135	CCMT060204	M025W060	Q08	0.20
C16-TB19-110	2	18.8	16	40	110	CCMT060204	M025W060	Q08	0.16
C16-TB19-160	2	18.8	16	40	160	CCMT060204	M025W060	Q08	0.24
C16-TB20-110	2	19.8	16	40	110	CCMT060204	M025W060	Q08	0.17
C16-TB20-160	2	19.8	16	40	160	CCMT060204	M025W060	Q08	0.25
C20-TB21-120	2	20.8	20	40	120	CCMT060204	M025W060	Q08	0.27
C20-TB21-160	2	20.8	20	40	160	CCMT060204	M025W060	Q08	0.37
C20-TB22-120	2	21.8	20	40	120	CCMT060204	M025W060	Q08	0.28
C20-TB22-160	2	21.8	20	40	160	CCMT060204	M025W060	Q08	0.38
C20-TB23-120	2	22.8	20	40	120	CCMT060204	M025W060	Q08	0.28
C20-TB23-180	2	22.8	20	40	180	CCMT060204	M025W060	Q08	0.43
C20-TB24-120	2	23.8	20	40	120	CCMT060204	M025W060	Q08	0.29
C20-TB24-180	2	23.8	20	40	180	CCMT060204	M025W060	Q08	0.44
C20-TB25-120	2	24.8	20	40	120	CCMT060204	M025W060	Q08	0.29
C20-TB25-160	2	24.8	20	40	160	CCMT060204	M025W060	Q08	0.39
C20-TB25-190	2	24.8	20	40	190	CCMT060204	M025W060	Q08	0.47
C20-TB26-120	2	25.8	20	40	120	CCMT060204	M025W060	Q08	0.30
C20-TB26-190	2	25.8	20	40	190	CCMT060204	M025W060	Q08	0.47
C20-TB27-120	2	26.8	20	40	120	CCMT060204	M025W060	Q08	0.30
C20-TB27-190	2	26.8	20	40	190	CCMT060204	M025W060	Q08	0.48
C20-TB28-120	2	27.8	20	40	120	CCMT09T308	M040S100-1	Q15	0.28
C20-TB28-190	2	27.8	20	40	190	CCMT09T308	M040S100-1	Q15	0.46
C25-TB30-160	2	29.8	25	50	160	CCMT09T308	M040S100-1	Q15	0.58
C25-TB30-190	2	29.8	25	50	190	CCMT09T308	M040S100-1	Q15	0.70
C25-TB32-160	2	31.8	25	50	160	CCMT09T308	M040S100-1	Q15	0.60
C25-TB32-210	2	31.8	25	50	210	CCMT09T308	M040S100-1	Q15	0.79
C25-TB35-160	2	34.8	25	50	160	CCMT09T308	M040S100-1	Q15	0.61
C25-TB35-230	2	34.8	25	50	230	CCMT09T308	M040S100-1	Q15	0.88
C25-TB37-160	2	36.8	25	50	160	CCMT09T308	M040S100-1	Q15	0.63
C25-TB37-250	2	36.8	25	50	250	CCMT09T308	M040S100-1	Q15	0.97
C25-TB40-160	2	39.8	25	50	160	CCMT09T308	M040S100-1	Q15	0.68
C32-TB40-250	2	39.8	32	50	250	CCMT09T308	M040S100-1	Q15	1.03
C32-TB42-200	2	41.8	32	50	200	CCMT09T308	M040S100-1	Q15	1.27
C32-TB42-250	2	41.8	32	50	250	CCMT09T308	M040S100-1	Q15	1.59
C32-TB45-200	2	44.8	32	50	200	CCMT09T308	M040S100-1	Q15	1.31
C32-TB45-310	2	44.8	32	50	310	CCMT09T308	M040S100-1	Q15	2.01
C32-TB47-200	2	46.8	32	50	200	CCMT09T308	M040S100-1	Q15	1.34
C32-TB47-260	2	46.8	32	50	260	CCMT09T308	M040S100-1	Q15	1.72
C32-TB50-200	2	49.8	32	50	200	CCMT09T308	M040S100-1	Q15	1.38
C32-TB50-310	2	49.8	32	50	310	CCMT09T308	M040S100-1	Q15	2.07



## BORING HEAD HOLDER

### HSK-DCK Boring Adapter

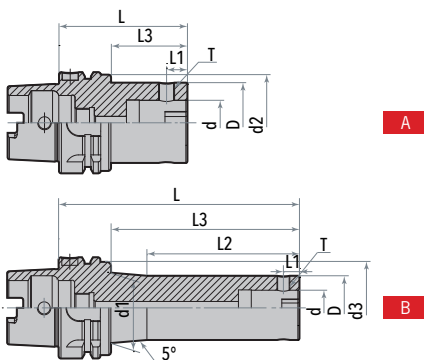

Specification	Figure	D	d	d1	d2	L1	L2	L3	L	Side-lock screw	Wrench	Weight	
HSK63A-	DCK1-70	A	19	11	-	-	5.05	-	-	70	M050Z050-30P-D	L025	0.72
	DCK1-100L	B	19	11	23.5	-	5.05	50	-	100	M050Z050-30P-D	L025	0.80
	DCK2-75	A	24	14	-	-	6.45	-	-	75	M050Z060-30P-D	L025	0.77
	DCK2-100	A	24	14	-	-	6.45	-	-	100	M050Z060-30P-D	L025	0.86
	DCK2-130L	B	24	14	31	-	6.45	65	-	130	M050Z060-30P-D	L025	1.00
	DCK3-80	A	31	18	-	-	7.9	-	-	80	M060Z090-30P-D	L03	0.90
	DCK3-100	A	31	18	-	-	7.9	-	-	100	M060Z090-30P-D	L03	1.00
	DCK3-135L	B	31	18	37	-	7.9	75	-	135	M060Z090-30P-D	L03	1.24
	DCK3-165L	B	31	18	41	-	7.9	85	-	165	M060Z090-30P-D	L03	1.48
	DCK4-70	A	39	22	-	-	10	-	-	70	M080Z120-30P-D	L04	0.94
	DCK4-100	A	39	22	-	-	10	-	-	100	M080Z120-30P-D	L04	1.21
	DCK4-150L	B	39	22	44	-	10	95	-	150	M080Z120-30P-D	L04	1.67
	DCK4-170L	B	39	22	47.5	-	10	95	-	170	M080Z120-30P-D	L04	1.90
	DCK5-80	A	50	28	-	-	13	-	-	80	M100Z160-30P-D	L05	1.26
	DCK5-100	A	50	28	-	-	13	-	-	100	M100Z160-30P-D	L05	1.53
	DCK5-150	A	50	28	-	-	13	-	-	150	M100Z160-30P-D	L05	2.29
	DCK5-180	A	50	28	-	-	13	-	-	180	M100Z160-30P-D	L05	2.74
	DCK6-100	A	64	36	-	-	16	-	-	100	M120Z200-30P-D	L06	1.93
	DCK6-150	A	64	36	-	-	16	-	-	150	M120Z200-30P-D	L06	3.18
	DCK6-180	A	64	36	-	-	16	-	-	180	M120Z200-30P-D	L06	3.89

See next page

# BORING HEAD HOLDER



## HSK-DCK Boring Adapter

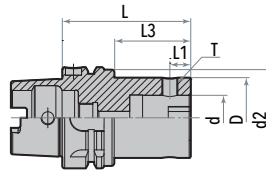

A

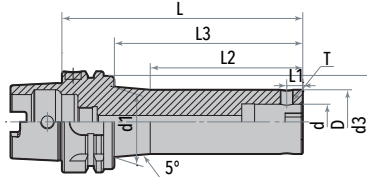

B

Specification	Figure	D	d	d1	d2	L1	L2	L3	L	Side-lock screw	Wrench	Weight	
HSK100A-	DCK1-80	A	19	11	-	65	5.05	-	43	80	M050Z050-30P-D	L025	2.27
	DCK1-115L	B	19	11	24	65	5.05	50	78	115	M050Z050-30P-D	L025	2.37
	DCK1-145L	B	19	11	27.5	65	5.05	60	108	145	M050Z050-30P-D	L025	2.46
	DCK2-80	A	24	14	-	65	6.45	-	43	80	M050Z060-30P-D	L025	2.31
	DCK2-105	A	24	14	-	65	6.45	-	68	105	M050Z060-30P-D	L025	2.40
	DCK2-135L	B	24	14	30	65	6.45	65	98	135	M050Z060-30P-D	L025	2.52
	DCK2-165L	B	24	14	33.5	65	6.45	75	128	165	M050Z060-30P-D	L025	2.67
	DCK3-85	A	31	18	-	65	7.9	-	46	85	M060Z090-30P-D	L03	2.40
	DCK3-110	A	31	18	-	65	7.9	-	71	110	M060Z090-30P-D	L03	2.57
	DCK3-140L	B	31	18	35.5	-	7.9	75	101	140	M060Z090-30P-D	L03	2.67
	DCK3-170L	B	31	18	41	-	7.9	85	-	170	M060Z090-30P-D	L03	2.90
	DCK4-100	A	39	22	-	-	10	-	-	100	M080Z120-30P-D	L04	2.53
	DCK4-160L	B	39	22	47	-	10	85	-	160	M080Z120-30P-D	L04	3.10
	DCK4-205L	B	39	22	50.5	-	10	110	-	205	M080Z120-30P-D	L04	3.62
	DCK5-90	A	50	28	-	-	13	-	-	90	M100Z160-30P-D	L05	2.72
	DCK5-165	A	50	28	-	-	13	-	-	165	M100Z160-30P-D	L05	3.82
	DCK5-210L	B	50	28	61	-	13	120	-	210	M100Z160-30P-D	L05	4.60
	DCK5-270L	B	50	28	69.5	-	13	130	-	270	M100Z160-30P-D	L05	6.09
	DCK6-85	A	64	36	-	-	16	-	-	85	M120Z200-30P-D	L06	3.05
	DCK6-155	A	64	36	-	-	16	-	-	155	M120Z200-30P-D	L06	4.75
	DCK6-215	A	64	36	-	-	16	-	-	215	M120Z200-30P-D	L06	6.10
	DCK6-250	A	64	36	-	-	16	-	-	250	M120Z200-30P-D	L06	7.04
	DCK6-300L	B	64	36	80	-	16	180	-	300	M120Z200-30P-D	L06	8.80
	DCK7-125	A	90	46	-	-	19.15	-	-	125	M200Z290-30P-D	L10	5.73
DCK7-200	A	90	46	-	-	19.15	-	-	200	M200Z290-30P-D	L10	9.30	
DCK7-275	A	90	46	-	-	19.15	-	-	275	M200Z290-30P-D	L10	12.90	

### Feature

1. The whole bar with through holes, be useful for coolant and anti-shanking.
2. Be compatible with all "CK" series.
3. Side lock screw is at right angles to key slot, to make sure that the replacing holders in CNC machine are always in phase.
4. Please apply lubricating oil to the screw to avoid stuck.



## BORING HEAD HOLDER

### BT-DCK Boring Adapter

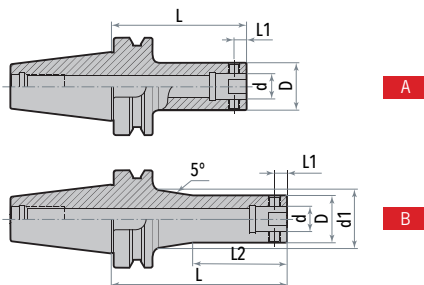

Specification	Figure	D	d1	d	L1	L2	L	Side-lock screw	Wrench	Weight	
BT30-	DCK1-55	A	19	-	11	5.05	-	55	M050Z050-30P-D	L025	0.42
	DCK1-70	A	19	-	11	5.05	-	70	M050Z050-30P-D	L025	0.47
	DCK2-80	A	24	-	14	6.45	-	80	M050Z060-30P-D	L025	0.55
	DCK3-80	A	31	-	18	7.9	-	80	M060Z090-30P-D	L03	0.66
	DCK4-70	A	39	-	22	10	-	70	M080Z120-30P-D	L04	0.72
	DCK5-70	A	50	-	28	13	-	70	M100Z160-30P-D	L05	0.89
	DCK6-65	A	64	-	36	16	-	65	M120Z200-30P-D	L06	0.88
BT40-	DCK1-70	A	19	-	11	5.05	-	70	M050Z050-30P-D	L025	1.06
	DCK1-100L	B	19	20.7	11	5.05	60	100	M050Z050-30P-D	L025	1.10
	DCK1-130L	B	19	25.9	11	5.05	60	130	M050Z050-30P-D	L025	1.25
	DCK2-75	A	24	-	14	6.45	-	75	M050Z060-30P-D	L025	1.10
	DCK2-100	A	24	-	14	6.45	-	100	M050Z060-30P-D	L025	1.19
	DCK2-130L	B	24	30	14	6.45	65	130	M050Z060-30P-D	L025	1.33
	DCK2-160L	B	24	33.6	14	6.45	75	160	M050Z060-30P-D	L025	1.49
	DCK3-80	A	31	-	18	7.9	-	80	M060Z090-30P-D	L03	1.22
	DCK3-100	A	31	-	18	7.9	-	100	M060Z090-30P-D	L03	1.34
	DCK3-135L	B	31	34.5	18	7.9	75	135	M060Z090-30P-D	L03	1.57
	DCK3-165L	B	31	39.7	18	7.9	85	165	M060Z090-30P-D	L03	1.81
	DCK4-70	A	39	-	22	10	-	70	M080Z120-30P-D	L04	1.24
	DCK4-100	A	39	-	22	10	-	100	M080Z120-30P-D	L04	1.50
	DCK4-150L	B	39	43.4	22	10	85	150	M080Z120-30P-D	L04	1.97
	DCK4-170L	B	39	46.9	22	10	95	170	M080Z120-30P-D	L04	2.18
	DCK5-60	A	50	-	28	13	-	60	M100Z160-30P-D	L05	1.26
	DCK5-80	A	50	-	28	13	-	80	M100Z160-30P-D	L05	1.54
	DCK5-100	A	50	-	28	13	-	100	M100Z160-30P-D	L05	1.82
	DCK5-150	A	50	-	28	13	-	150	M100Z160-30P-D	L05	2.53
	DCK5-180	A	50	-	28	13	-	180	M100Z160-30P-D	L05	2.96
	DCK6-55	A	64	-	36	16	-	55	M120Z200-30P-D	L06	1.25
	DCK6-100	A	64	-	36	16	-	100	M120Z200-30P-D	L06	2.33
	DCK6-150	A	64	-	36	16	-	150	M120Z200-30P-D	L06	3.52
DCK6-180	A	64	-	36	16	-	180	M120Z200-30P-D	L06	4.25	

See next page 

# BORING HEAD HOLDER



## BT-DCK Boring Adapter

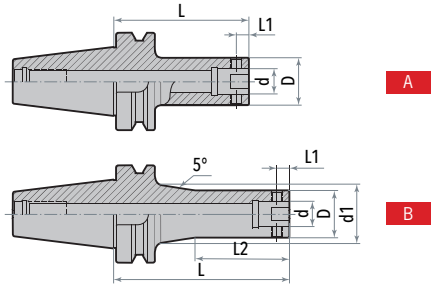

Specification	Figure	D	d1	d	L1	L2	L	Side-lock screw	Wrench	Weight	
BT50-	DCK1-80	A	19	-	11	5.05	-	80	M050Z050-30P-D	L025	3.63
	DCK1-115L	B	19	22.2	11	5.05	50	115	M050Z050-30P-D	L025	3.81
	DCK1-145L	B	19	26	11	5.05	60	145	M050Z050-30P-D	L025	3.91
	DCK2-80	A	24	-	14	6.45	-	80	M050Z060-30P-D	L025	3.66
	DCK2-105	A	24	-	14	6.45	-	105	M050Z060-30P-D	L025	3.74
	DCK2-135L	B	24	26.6	14	6.45	65	135	M050Z060-30P-D	L025	3.96
	DCK2-165L	B	24	31.9	14	6.45	75	165	M050Z060-30P-D	L025	4.12
	DCK3-85	A	31	-	18	7.9	-	85	M060Z090-30P-D	L03	3.77
	DCK3-110	A	31	-	18	7.9	-	110	M060Z090-30P-D	L03	4.00
	DCK3-140L	B	31	34.2	18	7.9	75	140	M060Z090-30P-D	L03	4.19
	DCK3-170L	B	31	38	18	7.9	85	170	M060Z090-30P-D	L03	4.42
	DCK4-100	A	39	-	22	10	-	100	M080Z120-30P-D	L04	4.00
	DCK4-160L	B	39	42.5	22	10	85	160	M080Z120-30P-D	L04	4.62
	DCK4-205L	B	39	50	22	10	95	205	M080Z120-30P-D	L04	5.18
	DCK5-90	A	50	-	28	13	-	90	M100Z160-30P-D	L05	4.18
	DCK5-165	A	50	-	28	13	-	165	M100Z160-30P-D	L05	5.24
	DCK5-210L	B	50	57.8	28	13	120	210	M100Z160-30P-D	L05	6.00
	DCK5-270L	B	50	68.4	28	13	120	270	M100Z160-30P-D	L05	7.50
	DCK6-85	A	64	-	36	16	-	85	M120Z200-30P-D	L06	4.39
	DCK6-155	A	64	-	36	16	-	155	M120Z200-30P-D	L06	6.00
	DCK6-215	A	64	-	36	16	-	215	M120Z200-30P-D	L06	7.50
	DCK6-250	A	64	-	36	16	-	250	M120Z200-30P-D	L06	8.35
	DCK6-300L	B	64	80.5	36	16	160	300	M120Z200-30P-D	L06	10.34
	DCK6-350L	B	64	90	36	16	160	350	M120Z200-30P-D	L06	12.57
	DCK7-85	A	90	-	46	19.15	-	85	M200Z290-30P-D	L10	1.96
	DCK7-150	A	90	-	46	19.15	-	150	M200Z290-30P-D	L10	8.00
	DCK7-210	A	90	-	46	19.15	-	210	M200Z290-30P-D	L10	10.87
	DCK7-250	A	90	-	46	19.15	-	250	M200Z290-30P-D	L10	12.80
	DCK7-300	A	90	-	46	19.15	-	300	M200Z290-30P-D	L10	15.00
	DCK7-350	A	90	-	46	19.15	-	350	M200Z290-30P-D	L10	17.50

### Feature

1. The whole bar with through holes, be useful for coolant and anti-shanking.
2. Be compatible with all" CK" series.
3. Side lock screw is at right angles to key slot, to make sure that the replacing holders in CNC machine are always in phase.
4. Please apply lubricating oil to the screw to avoid stuck.



## BORING HEAD HOLDER

### BBT-DCK Boring Adapter

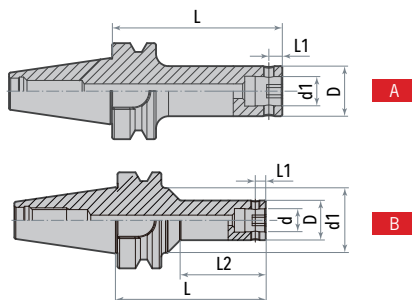

Specification	Figure	D	d1	d	L1	L2	L	Side-lock screw	Wrench	Weight	
BBT30-	DCK1-72	B	19	31	11	5	41	72	M050Z050-30P-D	L02	0.50
	DCK2-37.5	A	24	-	14	6.45	-	37.5	M050Z060-30P-D	L025	0.42
	DCK2-82.5	A	24	-	14	6.45	-	82.5	M050Z060-30P-D	L025	0.57
	DCK3-39	A	31	-	18	7.9	-	39	M060Z090-30P-D	L03	0.44
	DCK3-79	A	31	-	18	7.9	-	79	M060Z090-30P-D	L03	0.67
	DCK4-38	A	39	-	22	10	-	38	M080Z120-30P-D	L04	0.45
	DCK4-73	A	39	-	22	10	-	73	M080Z120-30P-D	L04	0.76
	DCK5-63	A	50	-	28	13	-	63	M100Z160-30P-D	L05	0.80
DCK6-64	A	64	-	36	16	-	64	M120Z200-30P-D	L06	0.92	
BBT40-	DCK1-72	A	19	-	11	5	-	72	M050Z050-30P-D	L02	1.07
	DCK2-42.5	A	24	-	14	6.45	-	42.5	M050Z060-30P-D	L025	1.00
	DCK2-82.5	A	24	-	14	6.45	-	82.5	M050Z060-30P-D	L025	1.14
	DCK3-44	A	31	-	18	7.9	-	44	M060Z090-30P-D	L03	1.04
	DCK3-94	A	31	-	18	7.9	-	94	M060Z090-30P-D	L03	1.30
	DCK3-124	A	31	-	18	7.9	-	124	M060Z090-30P-D	L03	1.50
	DCK4-43	A	39	-	22	10	-	43	M080Z120-30P-D	L04	1.00
	DCK4-88	A	39	-	22	10	-	88	M080Z120-30P-D	L04	1.40
	DCK4-118	A	39	-	22	10	-	118	M080Z120-30P-D	L04	1.66
	DCK4-148	A	39	-	22	10	-	148	M080Z120-30P-D	L04	1.92
	DCK5-48	A	50	-	28	13	-	48	M100Z160-30P-D	L05	1.00
	DCK5-78	A	50	-	28	13	-	78	M100Z160-30P-D	L05	1.50
	DCK5-108	A	50	-	28	13	-	108	M100Z160-30P-D	L05	1.95
	DCK5-138	A	50	-	28	13	-	138	M100Z160-30P-D	L05	2.38
	DCK6-64	A	64	-	36	16	-	64	M120Z200-30P-D	L06	1.47
	DCK6-94	A	64	-	36	16	-	94	M120Z200-30P-D	L06	2.19
DCK6-124	A	64	-	36	16	-	124	M120Z200-30P-D	L06	2.90	

See next page 

# BORING HEAD HOLDER



## BBT-DCK Boring Adapter

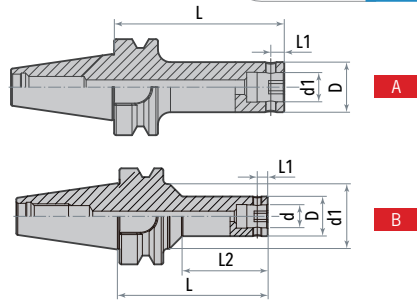

Specification	Figure	D	d1	d	L1	L2	L	Side-lock screw	Wrench	Weight
BBT50-DCK1-102	A	19	-	11	5	-	102	M050Z050-30P-D	L02	3.81
DCK2-52.5	A	24	-	14	6.45	-	52.5	M050Z060-30P-D	L025	3.70
DCK2-112.5	A	24	-	14	6.45	-	112.5	M050Z060-30P-D	L025	3.90
DCK3-54	A	31	-	18	7.9	-	54	M060Z090-30P-D	L03	3.70
DCK3-124	A	31	-	18	7.9	-	124	M060Z090-30P-D	L03	4.12
DCK4-58	A	39	-	22	10	-	58	M080Z120-30P-D	L04	3.73
DCK4-118	A	39	-	22	10	-	118	M080Z120-30P-D	L04	4.23
DCK4-178	A	39	-	22	10	-	178	M080Z120-30P-D	L04	4.73
DCK4-208	A	39	-	22	10	-	208	M080Z120-30P-D	L04	5.00
DCK5-63	A	50	-	28	13	-	63	M100Z160-30P-D	L05	3.80
DCK5-108	A	50	-	28	13	-	108	M100Z160-30P-D	L05	4.43
DCK5-183	A	50	-	28	13	-	183	M100Z160-30P-D	L05	5.53
DCK5-228	A	50	-	28	13	-	228	M100Z160-30P-D	L05	6.16
DCK5-263	A	50	-	28	13	-	263	M100Z160-30P-D	L05	6.67
DCK6-94	A	64	-	36	16	-	94	M120Z200-30P-D	L06	4.60
DCK6-169	A	64	-	36	16	-	169	M120Z200-30P-D	L06	6.51
DCK6-229	A	64	-	36	16	-	229	M120Z200-30P-D	L06	7.88
DCK6-289	A	64	-	36	16	-	289	M120Z200-30P-D	L06	9.32
DCK7-93	A	90	-	46	19.2	-	93	M200Z290-30P-D	L10	5.37
DCK7-183	A	90	-	46	19.2	-	183	M200Z290-30P-D	L10	9.70
DCK7-243	A	90	-	46	19.2	-	243	M200Z290-30P-D	L10	12.50

### Feature

1. The whole bar with through holes, be useful for coolant and anti-shanking.
2. Be compatible with all " CK" series.
3. Side lock screw is at right angles to key slot, to make sure that the replacing holders in CNC machine are always in phase.
4. Please apply lubricating oil to the screw to avoid stuck.



## BORING HEAD HOLDER

### SK-DCK Boring Adapter

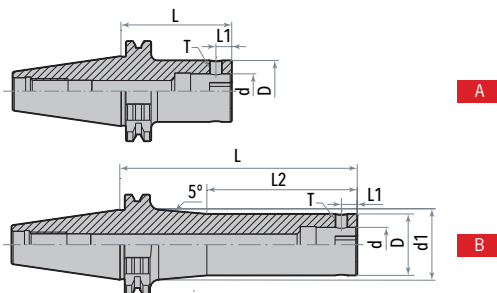

Specification	Figure	D	d1	d	L1	L2	L	Side-lock screw	Wrench	Weight	
SK30-	DCK1-55	A	19	-	11	5.05	-	55	M050Z050-30P-D	L025	0.42
	DCK1-70	A	19	-	11	5.05	-	70	M050Z050-30P-D	L025	0.45
	DCK2-80	A	24	-	14	6.45	-	80	M050Z060-30P-D	L025	0.54
	DCK3-80	A	31	-	18	7.9	-	80	M060Z090-30P-D	L03	0.66
	DCK4-70	A	39	-	22	10	-	70	M080Z120-30P-D	L04	0.70
	DCK5-70	A	50	-	28	13	-	70	M100Z160-30P-D	L05	0.85
DCK6-80	A	64	-	36	16	-	80	M120Z200-30P-D	L06	1.24	
SK40-	DCK1-70	A	19	-	11	5.05	-	70	M050Z050-30P-D	L025	0.89
	DCK1-100L	B	19	23.5	11	5.05	23.5	100	M050Z050-30P-D	L025	0.99
	DCK2-75.	A	24	-	14	6.45	-	75	M050Z060-30P-D	L025	0.97
	DCK2-100	A	24	-	14	6.45	-	100	M050Z060-30P-D	L025	1.06
	DCK2-130L	B	24	31.1	14	6.45	31.1	130	M050Z060-30P-D	L025	1.21
	DCK2-160L	B	24	34.6	14	6.45	34.6	160	M050Z060-30P-D	L025	1.38
	DCK3-80	A	31	-	18	7.9	-	80	M060Z090-30P-D	L03	1.11
	DCK3-100	A	31	-	18	7.9	-	100	M060Z090-30P-D	L03	1.22
	DCK3-135L	B	31	31.6	18	7.9	31.6	135	M060Z090-30P-D	L03	1.44
	DCK3-165L	B	31	41.4	18	7.9	41.4	165	M060Z090-30P-D	L03	1.73
	DCK4-70	A	39	-	22	10	-	70	M080Z120-30P-D	L04	1.14
	DCK4-100	A	39	-	22	10	-	100	M080Z120-30P-D	L04	1.41
	DCK4-150L	B	39	46.8	22	10	46.8	150	M080Z120-30P-D	L04	1.90
	DCK4-170L	B	39	46.8	22	10	46.8	170	M080Z120-30P-D	L04	2.13
	DCK5-80	A	50	-	28	13	-	80	M100Z160-30P-D	L05	1.49
	DCK5-100	A	50	-	28	13	-	100	M100Z160-30P-D	L05	1.75
	DCK5-150	A	50	-	28	13	-	150	M100Z160-30P-D	L05	2.48
	DCK5-180	A	50	-	28	13	-	180	M100Z160-30P-D	L05	2.92
	DCK6-90	A	64	-	36	16	-	90	M120Z200-30P-D	L06	1.98
	DCK6-150	A	64	-	36	16	-	150	M120Z200-30P-D	L06	3.40
DCK6-180	A	64	-	36	16	-	180	M120Z200-30P-D	L06	4.10	

See next page



# BORING HEAD HOLDER



## SK-DCK Boring Adapter

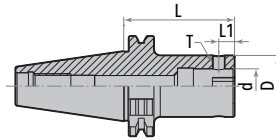

A

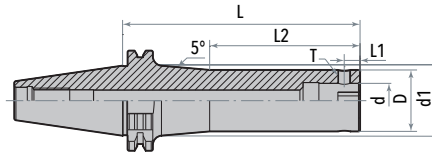

B

Specification	Figure	D	d1	d	L1	L2	L	Side-lock screw	Wrench	Weight	
SK50-	DCK1-80	B	19	-	11	5.05	-	80	M050Z050-30P-D	L025	2.73
	DCK1-115L	B	19	25.8	11	5.05	60	115	M050Z050-30P-D	L025	2.84
	DCK1-145L	B	19	29.3	11	5.05	60	145	M050Z050-30P-D	L025	3.00
	DCK2-80	A	24	-	14	6.45	-	80	M050Z060-30P-D	L025	2.83
	DCK2-105	A	24	-	14	6.45	-	105	M050Z060-30P-D	L025	2.91
	DCK2-135L	B	24	31.7	14	6.45	75	135	M050Z060-30P-D	L025	3.00
	DCK2-165L	B	24	35.2	14	6.45	75	165	M050Z060-30P-D	L025	3.20
	DCK3-85	A	31	-	18	7.9	-	85	M060Z090-30P-D	L03	2.98
	DCK3-110	A	31	-	18	7.9	-	110	M060Z090-30P-D	L03	3.13
	DCK3-140L	B	31	37.8	18	7.9	85	140	M060Z090-30P-D	L03	3.30
	DCK3-170L	B	31	41.3	18	7.9	85	170	M060Z090-30P-D	L03	3.57
	DCK4-100	A	39	-	22	10	-	100	M080Z120-30P-D	L04	3.24
	DCK4-160L	B	39	47.5	22	10	95	160	M080Z120-30P-D	L04	3.90
	DCK4-205L	B	39	53.7	22	10	95	205	M080Z120-30P-D	L04	4.50
	DCK5-90	A	50	-	28	13	-	90	M100Z160-30P-D	L05	3.40
	DCK5-165	A	50	-	28	13	-	165	M100Z160-30P-D	L05	4.53
	DCK5-210L	B	50	61.2	28	13	120	210	M100Z160-30P-D	L05	5.45
	DCK5-270L	B	50	71.7	28	13	120	270	M100Z160-30P-D	L05	7.10
	DCK6-85	A	64	-	36	16	-	85	M120Z200-30P-D	L06	3.90
	DCK6-155	A	64	-	36	16	-	155	M120Z200-30P-D	L06	5.54
DCK6-215	A	64	-	36	16	-	215	M120Z200-30P-D	L06	6.96	
DCK6-250	A	64	-	36	16	-	250	M120Z200-30P-D	L06	7.80	
DCK6-300L	B	64	75	36	16	160	300	M120Z200-30P-D	L06	9.60	
DCK7-85	A	90	-	46	19.15	-	85	M200Z290-30P-D	L10	4.73	
DCK7-150	A	90	-	46	19.15	-	150	M200Z290-30P-D	L10	7.80	
DCK7-210	A	90	-	46	19.15	-	210	M200Z290-30P-D	L10	10.63	
DCK7-250	A	90	-	46	19.15	-	250	M200Z290-30P-D	L10	12.53	
DCK7-300	A	90	-	46	19.15	-	300	M200Z290-30P-D	L10	14.89	
DCK7-350	A	90	-	46	19.15	-	350	M200Z290-30P-D	L10	17.32	

### Feature

1. The whole bar with through holes, be useful for coolant and anti-shanking.
2. Be compatible with all " CK " series.
3. Side lock screw is at right angles to key slot, to make sure that the replacing holders in CNC machine are always in phase.
4. Please apply lubricating oil to the screw to avoid stuck.



## BORING HEAD HOLDER

### CAT-DCK Boring Adapter

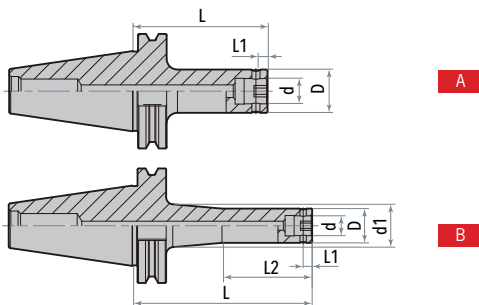

Specification	Figure	D	d1	d	L1	L2	L	Side-lock screw	Wrench	Weight
CAT40-	DCK1-100L	B	19	23.8	11	5	50	M050Z050-30P-D	L020	1.01
	DCK2-75	A	24	-	14	6.45	-	M050Z060-30P-D	L025	0.99
	DCK3-100	A	31	-	18	7.9	-	M060Z090-30P-D	L03	1.24
	DCK4-60	A	39	-	22	10	-	M080Z120-30P-D	L04	1.08
	DCK4-100	A	39	-	22	10	-	M080Z120-30P-D	L04	1.46
	DCK5-60	A	50	-	28	13	-	M100Z160-30P-D	L05	1.22
	DCK5-100	A	50	-	28	13	-	M100Z160-30P-D	L05	1.79
	DCK6-65	A	64	-	36	16	-	M120Z200-30P-D	L06	1.52
DCK6-100	A	64	-	36	16	-	M120Z200-30P-D	L06	2.37	
CAT50-	DCK1-115L	B	19	25.4	11	5	50	M050Z050-30P-D	L020	2.90
	DCK2-105	A	24	-	14	6.45	-	M050Z060-30P-D	L025	2.92
	DCK3-110	A	31	-	18	7.9	-	M060Z090-30P-D	L03	3.13
	DCK4-100	A	39	-	22	10	-	M080Z120-30P-D	L04	3.25
	DCK5-165	A	50	-	28	13	-	M100Z160-30P-D	L05	4.56
	DCK6-155	A	64	-	36	16	-	M120Z200-30P-D	L06	5.56
	DCK7-100	A	90	-	46	19.2	-	M200Z290-30P-D	L10	5.58

### NBH2084 Boring Adapter

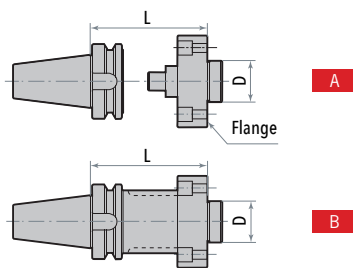

Specification	D	L	Locking screw	Wrench	Weight
BT40-NBH-A50	35	50	E080U200	L06	1.78
BT50-NBH-A50	35	50	E080U200	L06	4.16
NBH-FP60	35	Flange	-	-	0.60
BT40-NBH-B100	35	50	E080U300	L06	2.23
BT50-NBH-B100	35	50	E080U300	L06	4.84

Specification	D	L	Locking screw	Wrench	Weight	
BT50-	NBH-B165	35	165	E080U200	L06	6.23
	NBH-B200	35	200	E080U200	L06	7.01
	NBH-B250	35	250	E080U300	L06	7.96
	NBH-B300	35	300	E080U300	L06	9.07



## FM

### Boring Adapter

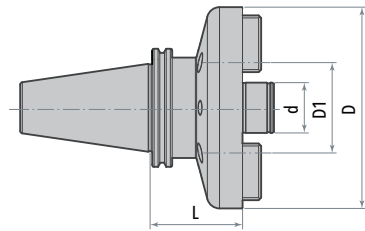

Specification		D	D1	d	L	Weight
HSK63A-	FMS40-70	87	66.7	40	70	2.30
HSK100A-	FMS40-60	87	66.7	40	60	3.55
	FMS40-150	87	66.7	40	150	7.68
	FMS40-250	87	66.7	40	250	12.26
	FMX40-80	160	101.6	40	80	7.61
	FMX40-150	160	101.6	40	150	10.53
	FMX40-250	160	101.6	40	250	14.69

Specification		D	D1	d	L	Weight
SK50-	FMS40-50	89	66.7	40	50	4.08
	FMS40-150	89	66.7	40	150	8.88
	FMS40-250	89	66.7	40	250	13.68
	FMX40-75	160	101.6	40	75	8.46
	FMX40-150	160	101.6	40	150	11.37
	FMX40-250	160	101.6	40	250	15.30

Specification		D	D1	d	L	Weight
CAT50-	FMS40-50	89	66.7	40	50	4.22
	FMS40-150	89	66.7	40	150	9.01
	FMX40-75	160	101.6	40	75	8.29
	FMX40-150	160	101.6	40	150	11.41

Specification		D	D1	d	L	Weight
BT40-	FMS40-70	87	66.7	40	70	2.85
	FMS40-120	87	66.7	40	120	5.20
BT50-	FMS40-55	87	66.7	40	55	4.28
	FMS40-150	87	66.7	40	150	8.88
	FMS40-200	87	66.7	40	200	10.92
	FMS40-250	87	66.7	40	250	13.21
	FMS40-300	87	66.7	40	300	15.50
	FMX40-85	160	101.6	40	85	8.90
	FMX40-150	160	101.6	40	150	11.60
	FMX40-200	160	101.6	40	200	13.69
	FMX40-250	160	101.6	40	250	15.77
	FMX40-300	160	101.6	40	300	17.85

Specification		D	D1	d	L	Weight
BBT50-	FMS40-55	87	66.7	40	55	4.35
	FMS40-150	87	66.7	40	150	8.70
	FMX40-85	160	101.6	40	85	8.97
	FMX40-150	160	101.6	40	150	11.67



## BORING HEAD HOLDER

### DCK Extension

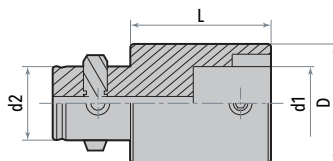

Specification	D	d1	d2	L	Side-lock screw	Wrench	Weight
DCK 1-1-30	19	11	11	30	M050Z050-30P-D	L025	0.06
2-2-30	24	14	14	30	M050Z060-30P-D	L025	0.09
3-3-30	31	18	18	30	M060Z090-30P-D	L03	0.14
4-4-45	39	22	22	45	M080Z120-30P-D	L04	0.29
4-4-60	39	22	22	60	M080Z120-30P-D	L04	0.47
5-5-60	50	28	28	60	M100Z160-30P-D	L05	0.75
5-5-90	50	28	28	90	M100Z160-30P-D	L05	1.18
6-6-60	64	36	36	60	M120Z200-30P-D	L06	1.16
6-6-100	64	36	36	100	M120Z200-30P-D	L06	2.35
7-7-105	90	46	46	105	M200Z300-30P-D	L10	5.28

### DCK Reducer

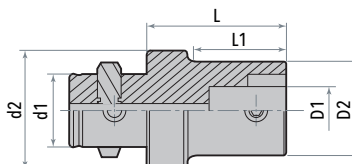

Specification	D1	D2	d1	d2	L1	L	Side-lock screw	Wrench	Weight
DCK 2-1-36	11	19	14	24	30	36	M050Z050-30P-D	L025	0.08
3-1-41	11	19	18	31	30	41	M050Z050-30P-D	L025	0.12
3-2-37	14	24	18	31	25	37	M050Z060-30P-D	L025	0.13
4-1-58	11	19	22	39	40	58	M050Z050-30P-D	L025	0.24
4-2-50	14	24	22	39	36	50	M050Z060-30P-D	L025	0.22
4-3-50	18	31	22	39	37	50	M060Z090-30P-D	L03	0.30
5-1-60	11	19	28	50	40	60	M050Z050-30P-D	L025	0.38
5-2-54	14	24	28	50	35	54	M050Z060-30P-D	L025	0.38
5-2-74	14	24	28	50	55	74	M050Z060-30P-D	L025	0.45
5-3-47	18	31	28	50	29	47	M060Z090-30P-D	L03	0.46
5-3-72	18	31	28	50	54	72	M060Z090-30P-D	L03	0.54
5-4-42	22	39	28	50	25	42	M080Z120-30P-D	L04	0.43
5-4-67	22	39	28	50	50	67	M080Z120-30P-D	L04	0.62
6-1-70	11	19	36	64	40	70	M050Z050-30P-D	L025	0.90
6-2-63	14	24	36	64	45	63	M050Z060-30P-D	L025	0.66
6-2-93	14	24	36	64	75	93	M050Z060-30P-D	L025	0.71
6-3-56	18	31	36	64	39	56	M060Z090-30P-D	L03	0.70
6-3-96	18	31	36	64	79	96	M060Z090-30P-D	L03	0.91
6-4-51	22	39	36	64	35	51	M080Z120-30P-D	L04	0.76
6-4-101	22	39	36	64	85	101	M080Z120-30P-D	L04	1.19
6-5-41	28	50	36	64	25	41	M100Z160-30P-D	L05	0.72
6-5-91	28	50	36	64	75	91	M100Z160-30P-D	L05	1.46
7-6-106	36	64	46	90	81	106	M120Z200-30P-D	L06	3.12

# BORING HEAD HOLDER



## CR Chamfering Cutter

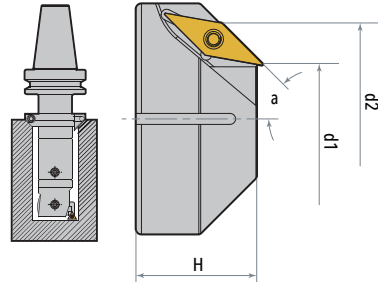

Assembled with DCK boring tools to chamfer.

Specification	Teeth	a	d1	d2	H	Adapter size	Wrench	Locking screw	Insert	Insert screw	Wrench	Weight	
CR	1-34-45	1	45	21	34	22	DCK1	L04	E050U160-D	VC**1103	M025W060	Q08	0.06
	2-39-45	1	45	26	39	25	DCK2	L04	E050U160-D	VC**1103	M025W060	Q08	0.12
	3-54-45	1	45	34	54	35	DCK3	L05	E060U200-D	VC**1604	M040S100-1	Q15	0.51
	4-62-45	1	45	42	62	38	DCK4	L05	E060U200-D	VC**1604	M040S100-1	Q15	0.69
	5-93-45	2	45	53	93	43	DCK5	L05	E060U250-D	VC**1604	M040S100-1	Q15	1.33
	6-107-45	2	45	67	107	46	DCK6	L06	E080U250-D	VC**1604	M040S100-1	Q15	1.84
	6-138-45	2	45	98	138	46	DCK6	L06	E080U250-D	VC**1604	M040S100-1	Q15	3.86
	6-160-45	2	45	120	160	46	DCK6	L06	E080U250-D	VC**1604	M040S100-1	Q15	5.58
CR	1-41-30	2	30	23	41	30	DCK1	L04	E050U160-D	VC**1103	M025W060	Q08	0.10
	2-46-30	2	30	28	46	35	DCK2	L04	E050U160-D	VC**1103	M025W060	Q08	0.21
	3-53-30	2	30	35	53	35	DCK3	L05	E060U200-D	VC**1103	M025W060	Q08	0.34
	4-61-30	2	30	43	61	35	DCK4	L05	E060U200-D	VC**1103	M025W060	Q08	0.41
	5-84-30	2	30	56	84	48	DCK5	L06	E080U250-D	VC**1604	M040S100-1	Q15	1.33
	6-98-30	2	30	70	98	48	DCK6	L06	E080U250-D	VC**1604	M040S100-1	Q15	1.21
	6-120-30	2	30	92	120	48	DCK6	L06	E080U250-D	VC**1604	M040S100-1	Q15	3.01
	6-142-30	2	30	114	142	48	DCK6	L06	E080U250-D	VC**1604	M040S100-1	Q15	4.09



## BORING HEAD HOLDER

### DCK Chamfering Head

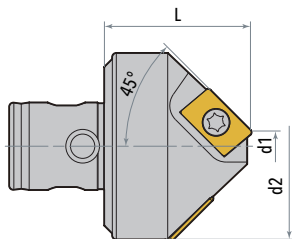

Connected with DCK boring adapter for chamfering.

Specification	Teeth	d1	d2	L	Adapter size	Insert	Insert screw	Wrench	
DCK	2-0522	1	5	22	25	DCK2	ADNT160308	M040Y080	Q15
	4-1046	2	10	46	36	DCK4	ADNT160308	M040Y080	Q15
	5-3065	2	30	65	50	DCK5	ADNT160308	M040Y080	Q15
	6-63100	2	63	100	60	DCK6	ADNT160308	M040Y080	Q15



## DCK-SCBH/SDCK/BT-SDCK/SCB-SDCK Anti-vibration Boring System

### Various Structural Forms

### Meet Diversified Machining Needs



#### SCBH Finish Boring

The boring head is equipped with vibration reduction, The function of CBH finish boring head remains unchanged, and they are synchronized with each other.

#### SDCK Boring Adaptor

Vibration reduction attached on DCK boring adaptor could receive better machining result during deep hole machining.

#### SDCK Extension

Smoothly interconnecting with existing standard boring head and boring adaptor by DCK connector and vibration reduction.

#### SCB-SDCK Boring Bar

Vibration reduction attached, DCK boring adaptor at the front and powerchucks with various cone at the back. And it also meets the needs of small but deep hole machining.

### Contrast Experiment

#### Machining Condition

Machine: Vertical machining center  
Cutting dia:  $\Phi 54$   
Radius: R0.2  
Feed: 0.1mm/rev  
Cutting output: 0.3mm/ $\Phi$

#### 42CrMo (HRC40) Finish Boring

× Vibrating ○ Steady ◎ Superior

Specification	Cutting speed (m/min)			
	50	80	100	150
BBT50-DCK5-263 DCK5-CBH53-95 (L/D=5.8)	○	×	×	×
BBT50-DCK5-263 DCK5-SCBH53-215 (L/D=8.6)	○	○	○	◎



## BORING HEAD HOLDER

### DCK-SCBH Anti-vibration Finish Boring

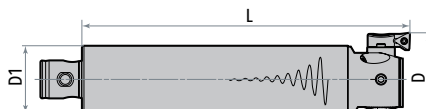

Specification	D1	L	Boring range	Adapter size	Cartridge	Insert	Screw	Wrench	Weight
DCK1-SCBH20-110	19	110	20-26	DCK1	CBH1-1	TPGH0802	M020D055	Q06	0.29
DCK2-SCBH25-130	24	130	25-33	DCK2	CBH2-1				0.55
DCK3-SCBH32-150	31	150	32-42	DCK3	CBH3-1				1.09
DCK4-SCBH41-190	39	190	41-54	DCK4	CBH4-1	TCMT1102 (With) TPGH1103 (For choice)	M025W060 M030W070	Q08	2.08
DCK5-SCBH53-215	50	215	53-70	DCK5	CBH5-1				3.86
DCK7-SCBH100-245	64	245	68-100	DCK6	CBH6-1				7.73
	90	245	100-153	DCK7	CBH6-1				11.73
	90	245	126-179	DCK7	CBH6-2				11.73
	90	245	150-203	DCK7	CBH6-3				11.73

### SDCK Anti-vibration Extension

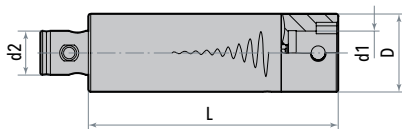

Specification	D1	d1	d2	L	Side-lock screw	Wrench	Weight
SDCK2-2-90	24	14	14	90	M050Z060-30P-D	L025	0.33
SDCK3-3-115	31	18	18	115	M060Z090-30P-D	L03	0.75
SDCK4-4-125	39	22	22	125	M080Z120-30P-D	L04	1.14
SDCK5-5-155	50	28	28	155	M100Z160-30P-D	L05	2.39
SDCK6-6-185	64	36	36	185	M120Z200-30P-D	L06	5.11

A



## BT-SDCK Anti-vibration Boring Adapter

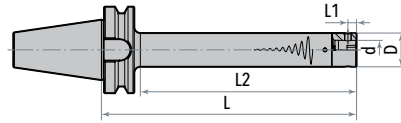

Specification	D	d	L1	L2	L	Side-lock screw	Wrench	Weight
BT40-SDCK2-145	24	14	6.45	110	145	M050Z060-30P-D	L025	1.44
BT40-SDCK2-170	24	14	6.45	135	170	M050Z060-30P-D	L025	1.54
BT40-SDCK2-195	24	14	6.45	160	195	M050Z060-30P-D	L025	1.64
BT40-SDCK3-195	31	18	7.9	160	195	M060Z090-30P-D	L03	2.15
BT40-SDCK3-225	31	18	7.9	190	225	M060Z090-30P-D	L03	2.37
BT40-SDCK3-255	31	18	7.9	220	255	M060Z090-30P-D	L03	2.59
BT40-SDCK4-240	39	22	10	205	240	M080Z120-30P-D	L04	3.07
BT40-SDCK4-280	39	22	10	245	280	M080Z120-30P-D	L04	3.50
BT40-SDCK4-320	39	22	10	285	320	M080Z120-30P-D	L04	3.93
BT40-SDCK5-315	50	28	13	283	315	M100Z160-30P-D	L05	5.65
BT50-SDCK2-165	24	14	6.45	117	165	M050Z060-30P-D	L025	4.12
BT50-SDCK2-190	24	14	6.45	142	190	M050Z060-30P-D	L025	4.22
BT50-SDCK2-215	24	14	6.45	167	215	M050Z060-30P-D	L025	4.32
BT50-SDCK3-205	31	18	7.9	160	205	M060Z090-30P-D	L03	4.80
BT50-SDCK3-235	31	18	7.9	190	235	M060Z090-30P-D	L03	5.02
BT50-SDCK3-265	31	18	7.9	220	265	M060Z090-30P-D	L03	5.24
BT50-SDCK4-255	39	22	10	210	255	M080Z120-30P-D	L04	5.89
BT50-SDCK4-295	39	22	10	250	295	M080Z120-30P-D	L04	6.27
BT50-SDCK4-335	39	22	10	290	335	M080Z120-30P-D	L04	6.65
BT50-SDCK5-315	50	28	13	270	315	M100Z160-30P-D	L05	8.51
BT50-SDCK5-360	50	28	13	315	360	M100Z160-30P-D	L05	9.30
BT50-SDCK5-405	50	28	13	360	405	M100Z160-30P-D	L05	10.09
BT50-SDCK6-380	64	36	16	335	380	M120Z200-30P-D	L06	12.56
BT50-SDCK6-445	64	36	16	400	445	M120Z200-30P-D	L06	14.24
BT50-SDCK6-510	64	36	16	465	510	M120Z200-30P-D	L06	15.93

## SCB-SDCK Anti-vibration Boring Bar

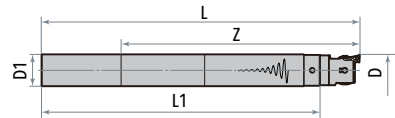

Specification	D1	D	Z	L1	L	Weight
SCB- C19-SDCK1-190	19	20-36	133	190	222	0.43
			190	272	272	0.77
C24-SDCK2-220	24	25-47	168	255	255	0.79
			240	315	315	1.43
C32-SDCK3-280	32	33-60	224	320	320	1.78
			320	390	390	3.24



### MKT

#### Boring Cartridge

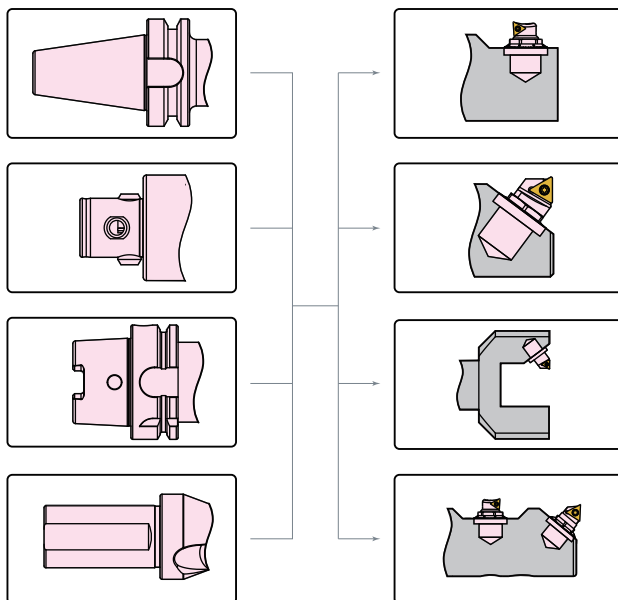

#### Notice

1. For non-standard tools.
2. Each scale means radial depth cut 0.01 mm; With side scale, the accuracy can be 0.001 mm.
3. With self-lock design.
4. Cartridge with different lead angle available on request.

#### Caution:

Don't over-adjust MKT cartridge. Safe adjusting size shouldn't access the wrench end size "d" (ref. picture A).

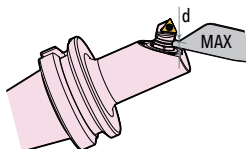



**MKT**  
Boring Cartridge

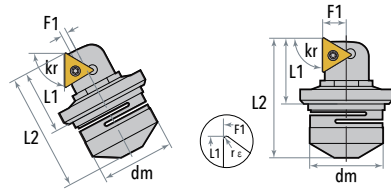

Right Hand

Specification	Fig	Kr	dm	L1	L2	F1	Dmin	$\lambda$	ic	Insert	Wrench	Weight	
MKT1-	90C06-L/R	A	90	16	14.3	25.15	0.45	25.5	-3	1/4	CC**0602	WMKT06	0.03
	90T06-L/R	A	90	16	14.3	25.0	0.50	24.8	0	5/32	TB**0601	WMKT06	0.03
	90T09-L/R	A	90	20	19.1	33.7	0.90	32.5	0	7/32	TC**0902	WMKT09	0.05
	90T11-L/R	A	90	22	23.0	45.3	1.10	42.0	0	1/4	TC**1102	WMKT11	0.18
	90T16-L/R	A	90	32	33.3	62.3	1.20	59.4	0	3/8	TC**16T3	WMKT16	0.21
MKT2-	90C06-L/R	B	90	16	13.3	24.1	5.10	27.0	-3	1/4	CC**0602	WMKT06	0.03
	90T09-L/R	B	90	20	18.3	32.9	6.30	36.5	0	7/32	TC**0902	WMKT09	0.05
	90T11-L/R	B	90	22	22.1	44.3	7.20	48.5	0	1/4	TC**1102	WMKT11	0.18
	90T16-L/R	B	90	32	32.0	62.7	10.3	68.4	0	3/8	TC**16T3	WMKT16	0.21

**MKT**  
Boring Cartridge - Assembling Size

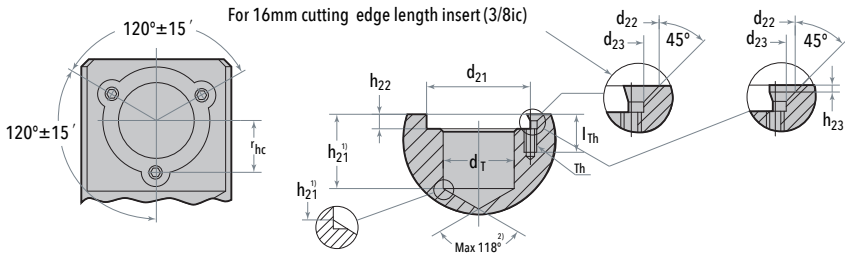

$\Delta$	ic	d <sub>7</sub> H7	d <sub>21</sub> <sup>1)</sup>	d <sub>22</sub> <sup>1)</sup>	d <sub>23</sub>	h <sub>21</sub> <sup>2)</sup>	h <sub>22</sub> <sup>3)</sup>	h <sub>23</sub> <sup>1)</sup>	l <sub>Th</sub>	r <sub>hc</sub>	T <sub>h</sub>
06	5/32	16	19	4.6	3.2	11.5	2.8	1.6	9	9.65 ± 0.02	M3
09	7/32	20	25	4.6	3.2	15.5	4.0	1.6	9	12.50 ± 0.05	M3
11	1/4	22	30	6.5	4.3	24.0	5.0	1.8	13	15.40 ± 0.05	M4
16	3/8	32	46	11.9	5.4	33.0	6.3	-	16	23.00 ± 0.05	M5
06	1/4	16	19	4.6	3.2	11.5	2.8	1.6	9	9.65 ± 0.02	M3

1)  $\begin{matrix} +0.1 \\ 0 \end{matrix}$

2)  $\begin{matrix} +0.2 \\ 0 \end{matrix}$

3) ± 0.2



**MKT**

**Boring Cartridge - Assembling Size**

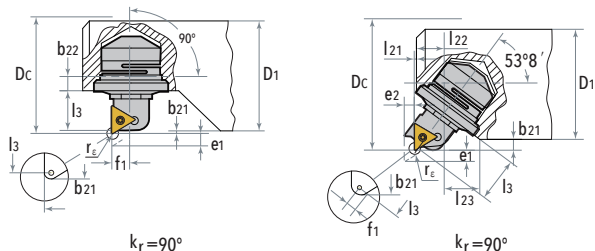

	$\Delta$	rE	D <sub>1</sub> min	D <sub>c</sub> min	b <sub>21</sub> min	e <sub>1</sub> max	e <sub>2</sub> max	b <sub>22</sub> min	l <sub>3</sub> min	l <sub>21</sub>	l <sub>22</sub>	l <sub>23</sub>	f <sub>1</sub>
	06	0.2	26.0	27.9	0.60	2.5	-	3.6	9.8	-	-	-	-
		0.4		27.6	0.55				9.6				
		0.8		27.0	0.50				9.1				
	09	0.2	34.5	37.4	1.45	3.5	-	4.55	13.95	-	-	-	-
		0.4		37.1	1.30				13.6				
		0.8		36.5	1.00				12.9				
	11	0.2	46.5	49.4	1.45	6	-	7.75	16.75	-	-	-	-
		0.4		49.1	1.30				16.4				
		0.8		48.5	1.00				15.7				
	16	0.4	67.0	69.6	1.30	10	-	9.40	25.0	-	-	-	-
		0.8		69.0	1.00				24.3				
		1.2		68.4	0.70				23.6				
	06	0.2	22.0	26.2	1.70	2	1.5	-	11.0	0.5	6.60	9.55	0.40
		0.4		25.9	1.65				10.7				0.40
		0.8		25.3	1.60				10.1				0.45
	06	0.2	22.0	25.7	1.50	2	1.5	-	10.9	0.5	6.60	9.55	0.40
		0.4		25.4	1.45				10.6				0.40
		0.8		24.8	1.40				10.0				0.45
	09	0.2	28.5	33.4	2.45	2.8	2.1	-	14.9	0.5	9.40	12.15	0.95
		0.4		33.1	2.30				14.5				1.00
		0.8		32.5	2.00				13.7				1.10
	11	0.2	38.0	42.9	2.45	4.8	3.6	-	17.6	0.5	11.20	14.85	1.15
		0.4		42.6	2.30				17.2				1.20
		0.8		42.0	2.00				16.4				1.30
	16	0.4	55.0	60.6	2.80	8	6.0	-	26.2	0.5	16.65	23.70	1.30
		0.8		60.0	2.50				25.4				1.40
		1.2		59.4	2.20				24.6				1.50

**Notice**

Above data is based on fully assembly.



## MAC Boring Cartridge

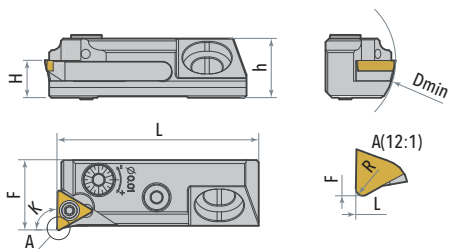

Specification	K	H	F	L	h1	Dmin	R	Suitable inserts
MAC90- F16-CC06-L/R	90	8.5	16	46	13.5	28	0.4	CC..0602..
MAC95- F16-CC06-L/R	95	8.5	16	46	13.5	28	0.4	CC..0602..
MAC90- F16-TP09-L/R	90	8.5	16	46	13.5	28	0.4	TP..0902..
MAC95- F16-TP09-L/R	95	8.5	16	46	13.5	28	0.4	TP..0902..
MAC90- F20-TC11-L/R	90	8.5	20	46	13.5	36	0.4	TC..1102..
MAC95- F20-TC11-L/R	95	8.5	20	46	13.5	36	0.4	TC..1102..
MAC90- F20-TP11-L/R	90	9	20	46	13.5	36	0.4	TP..1103..
MAC95- F20-TP11-L/R	95	9	20	46	13.5	36	0.4	TP..1103..

### Notice

1. With right hand type in stock.
2. Inserts need to be purchased based on different machined material.
3. One dial = 0.01mm.
4. Max radial adjustment is 0.6mm, max axial adjustment is 1mm.

### Item

Insert	Insert Screw	Axial Screw	Cartridge Screw	Insert Wrench	Cartridge Wrench	Radial Wrench	Axial Wrench
CC..0602..	M025W050	M050D200-90	E050U160	Q08	L04	L025	L03
TP..0902..	M025W050	M050D200-90	E050U160	Q08	L04	L025	L03
TC..1102..	M025W050	M050D200-90	E050U160	Q08	L04	L025	L03
TP..1103..	M030W060	M050D200-90	E050U160	Q08	L04	L025	L03



## MAC

### Boring Cartridge - Assembling Size

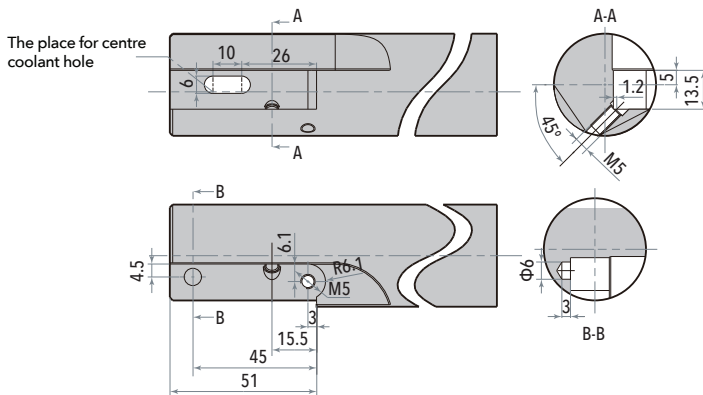

#### Notice

1. The way of adjustment on right hand type.
2. The opposite way of adjustment on left hand type.

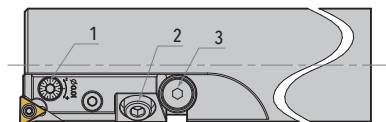

1. Radial Screw
2. Cartridge Screw
3. Axial Screw

#### Adjusting on axial direction

1. Loosening the 2# lock screw lightly.
2. Rotating the 3# axial screw in the anticlockwise direction, so that the cartridge can be moved forward to the required size.
3. Tightening the 2# lock screw firmly.

#### Adjusting on axial direction

1. Rotating the 1# radial adjusting screw in the clockwise direction, so that the diameter of tool will increase.
2. Rotating the 1# radial adjusting screw on the anticlockwise direction, so that the diameter of tool will reduce.
3. The adjustment on diameter: 0.01mm as per dial.

#### Notice

Note: If the cartridge should be moved backward, please loosen cartridge screw, and then move the cartridge to the back, finally adjust the cartridge to forward little by little to meet the required size.



**SFC**

**Inserts Holder SFC For Roughing**

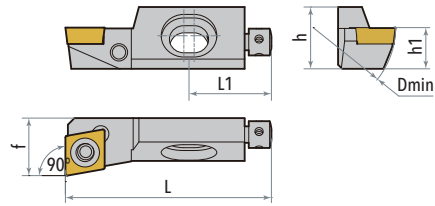

Specification	Dmin	h1	h	f	L1	L	Insert	Insert screw	Adjusting screw	Wrench	Weight
SCFCR08CA-06	25	8	10	10	17	32	CC**0602	M025W060	M040H120	Q08	0.07
SCFCR10CA-09	40	10	15	14	20	50	CC**09T3	M035W080	M040H120	Q15	0.10

**SFC**

**Inserts Holder SFC For Roughing**

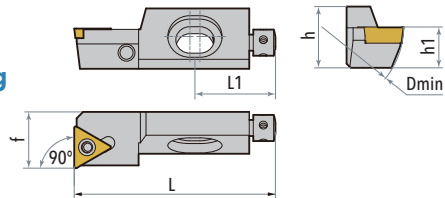

Specification	Dmin	h1	h	f	L1	L	Insert	Insert screw	Adjusting screw	Wrench	Weight
STFCR08CA-09	25	8	10	10	17	32	TC**0902	M022W060	M040H120	Q08	0.07
STFCR10CA-11	40	10	15	14	20	50	TC**1102	M025W060	M040H120	Q08	0.10

**SLC**

**Inserts Holder SLC For Roughing**

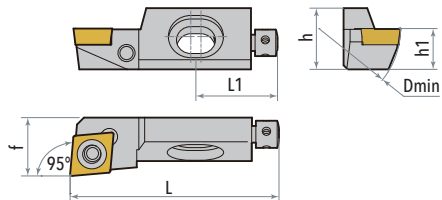

Specification	Dmin	h1	h	f	L1	L	Insert	Insert screw	Adjusting screw	Wrench	Weight
SCLCR08CA-06	25	8	10	10	17	32	CC**0602	M025W060	M040H120	Q08	0.07
SCLCR10CA-09	40	10	15	14	20	50	CC**09T3	M035W080	M040H120	Q15	0.10



## SSC

### Inserts Holder SSC For Roughing

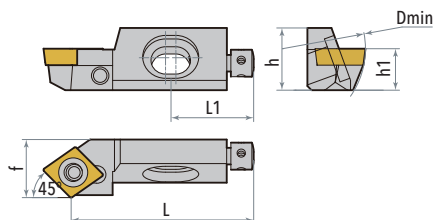

Specification	Dmin	h1	h	f	L1	L	Insert	Insert screw	Adjusting screw	Wrench	Weight
SCSCR08CA-06	25	8	10	10	17	32	CC**0602	M025W060	M040H120	Q08	0.07
SCSCR10CA-09	40	10	15	14	20	44	CC**09T3	M035W080	M040H120	Q15	0.09

## SSC

### Inserts Holder SSC For Roughing

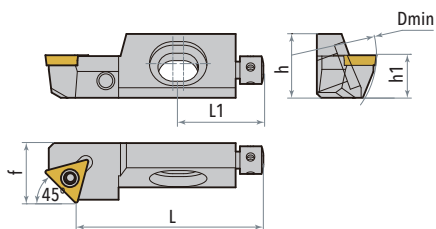

Specification	Dmin	h1	h	f	L1	L	Insert	Insert screw	Adjusting screw	Wrench	Weight
STSCR10CA-11	40	10	15	14	20	44	TC**1102	M022W060	M040H120	Q08	0.09
STSCR12CA-16	50	12	20	20	20	47	TC**16T3	M025W060	M050H130	Q15	0.15



**HSK**  
Blank Adapter

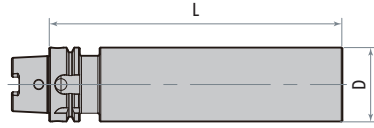

Specification		D	L
HSK50A-	63-200	52	200
	63-250	63	200
HSK63A-	52-200	63	250
	80-250	80	250
HSK100A-	63-200	63	200
	80-250	80	250
	90-300	90	300

**BT**  
Blank Adapter

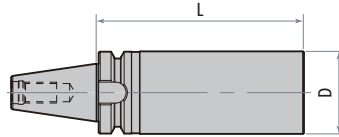

Specification		D	L
BT40-	63.5-160	63.5	160
	63.5-250	63.5	250
BT50-	80-200	80	200
	80-300	80	300

**SK**  
Blank Adapter

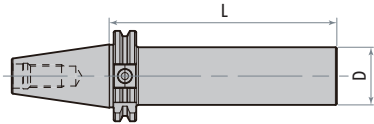

Specification		D	L
SK40-	40.5-160	40.5	160
	63.5-160	63.5	250
	63.5-250	63.5	250
SK50-	80-160	80	160
	80-200	80	200
	80-300	80	300

**Feature**

1. Hardness of shank: HRC55-60.
2. Hardness of blank:  $D \leq 65$ , HRC28-32;  $D > 65$ , HRC25-30.
3. Finish grinding for shank, finish lathing for blank.
4. Black coating for blank.
5. With intercoolant hole.